



HEINE
Veterinary catalogue 2023

General medicine & ENT instruments



HEINE G100 LED slit illumination head

With LED illumination in HEINE Quality – LED^{HQ}

LED^{HQ}
LED IN HEINE QUALITY



Instrument head with solid metal construction and scratch-resistant swivel lens guarantee a lifetime of maintenance-free use. LED with virtually unlimited hours of working life. No need to ever replace bulbs.

Slit illumination head. Allows optimal instrumentation with magnification and illumination. Clears the way for access during examinations.

- ∴ **Multi-coated, scratch-resistant swivel lens with 1.6x magnification** provides a high-resolution image.
 - ∴ **Fiber optic illumination.** Ensures homogeneous, very bright illumination and an unobstructed view of the ear canal and tympanum.
 - ∴ **There's LED. And there's LED^{HQ}.** HEINE has set a new standard which maintains that only the best is good enough, from the selection of materials to processing, from light intensity to dimmability, and from thermal management to a colour rendering index as high as possible. **That's what we call LED in HEINE Quality – or LED^{HQ}.**
 - ∴ **Special optical interface to precisely integrate the LED illumination with the optical system** to ensure bright homogeneous light during examinations.
 - ∴ **Patented, unique, stepless dimming** from 3% to 100% with practical one-finger operation.
 - ∴ **Easy cleaning.** Round edges allow easy disinfection, also with standard disinfectants.
 - ∴ **Double bayonet lock for specula.** Specula mounted firmly by double lock.
 - ∴ **Full functionality of the G100 LED slit illumination head is guaranteed with BETA rechargeable handles and the EN 200 / EN 200-1 wall transformers.**
- ∴ **Also available with XHL xenon halogen illumination.** Bright illumination and authentic colour rendering; for other technical specifications see G100 LED slit illumination head.



HEINE G100 diagnostic kit



[01]

Without case

G100 slit illumination head with

LED

BETA4 USB rechargeable handle with USB cord
and plug-in power supply [01]

G-010.28.388

BETA4 NT rechargeable handle with NT4 table charger

G-010.24.420

HEINE veterinary diagnostic sets

With XHL or LED^{HO} illumination



Set includes: G100 slit illumination head,

1 set long, closed specula (57mm x 4mm Ø, 65mm x 6mm Ø, 90mm x 7mm Ø),
 1 spare bulb for XHL version, hard case.

	2.5V XHL	3.5V XHL	LED
BETA battery handle	G-112.10.118		
BETA4 USB rechargeable handle with USB cord and plug-in power supply		G-112.27.388	G-112.28.388
BETA4 NT rechargeable handle with NT4 table charger		G-112.23.420	G-112.24.420



Set includes: G100 slit illumination head, ophthalmoscope BETA 200,

1 set long, closed specula (57mm x 4mm Ø, 65mm x 6mm Ø, 90mm x 7mm Ø),
 1 spare bulb each for XHL version, hard case.

	2.5V XHL	3.5V XHL	LED
BETA battery handle	G-148.10.118		
BETA4 USB rechargeable handle with USB cord and plug-in power supply		G-148.27.388	G-148.28.388
BETA4 NT rechargeable handle with NT4 table charger		G-148.23.420	G-148.24.420

∴ For further information on the HEINE BETA 200 ophthalmoscope, please see page 037.



HEINE BETA® 200 LED VET F.O. otoscope

Veterinary otoscope with LED^{HQ} illumination



The otoscope has been designed with an all metal housing and scratch resistant glass lenses which guarantee a lifetime of maintenance-free use. LED with virtually unlimited hours of working life. No need to ever replace bulbs. Maintenance-free for a lifetime.

- ∴ **Large, scratch-resistant glass viewing window with 2.5x magnification.** Specially developed lens for veterinary medicine. Focal length is designed specifically for use with longer specula.
- ∴ **Fiber optic illumination.** Ensures homogeneous, very bright illumination and an unobstructed view of the ear canal and tympanum.
- ∴ **There's LED. And there's LED^{HQ}.** HEINE has set a new standard which maintains that only the best is good enough, from the selection of materials to processing, from light intensity to dimmability, and from thermal management to a colour rendering index as high as possible. **That's what we call LED in HEINE Quality – or LED^{HQ}.**
- ∴ **Special optical interface to precisely integrate the LED illumination with the optical system** to ensure bright homogeneous light during examinations.
- ∴ **Patented, unique, stepless dimming** from 3% to 100% with practical one-finger operation.
- ∴ **Swivelling viewing window built into instrument.** Useful for instrumentation, cannot be mislaid.
- ∴ **Insufflation port.** Reliable test of tympanic mobility.
- ∴ **For use with reusable VET specula.** See order information accessories on pages 008–009.
- ∴ **Full functionality of the BETA 200 LED VET is guaranteed with BETA rechargeable handles and the EN 200 / EN 200-1 wall transformers.**

- ∴ **Also available with XHL xenon halogen illumination.** Bright illumination and authentic colour rendering; for other technical specifications see BETA 200 LED VET F.O. otoscope.

HEINE BETA 200 VET diagnostic kit

With XHL or LED^{HQ} illumination



Without case

BETA 200 VET F.O. otoscope with	2.5V XHL	3.5V XHL	LED
BETA battery handle	G-011.10.118		
BETA4 USB rechargeable handle with USB cord and plug-in power supply [01]		G-011.27.388	G-011.28.388
BETA4 NT rechargeable handle with NT4 table charger		G-011.23.420	G-011.24.420



Long, closed metal specula



- ∴ **Metal construction, chrome-plated.** Easy to clean, disinfect and sterilize.
- ∴ **Double bayonet lock for specula.** Firm mounting of specula to head.

Closed specula for G100/G100 LED slit illumination head

57 mm long / Ø 4 mm	G-000.21.330
65 mm long / Ø 6 mm	G-000.21.331
90 mm long / Ø 7 mm	G-000.21.332
170 mm long / Ø 10 mm	G-000.21.350

Slit metal specula, open



- ∴ **High-quality chrome-plated metal construction.** Easy to clean, disinfect and sterilize.
- ∴ **Matte internal surfaces.** Reduced reflexes.
- ∴ **60° opening with rounded edges.** Ideal for instrumentation, atraumatic insertion.
- ∴ **Double bayonet fitting.** Positive fit.

Slit metal specula for G100/G100 LED slit illumination head

65 mm long / Ø 6 mm	G-000.21.341
90 mm long / Ø 7 mm	G-000.21.342

Spreadable speculum for slit illumination head



This versatile instrument is widely used as a universal speculum for small animals.

- ∴ **Distal jaw opens up to 28 mm with 4 click-stops.** Useful for examination and therapy.
- ∴ **High-quality, chrome-plated metal construction.** Easy to clean, disinfect and sterilize.
- ∴ **Matte internal surfaces.** Avoids reflexes.
- ∴ **Oval branches with rounded edges.** Ideal for instrumentation, atraumatic.
- ∴ **2 bayonet locks.** Firm mounting of spreadable Speculum to head.

Spreadable speculum for G100/G100 LED slit illumination head

Spreadable speculum for slit illumination head (95 mm long)	G-000.21.360
---	--------------

Short, closed specula



- **Made of high-density SANALON S with a smooth external surface.** Dust and germs are easily removed. Common germicides can be used. Autoclavable at up to 134 °C.
- **Ergonomic shape.** Painless atraumatic insertion.
- **Integral metal ring with 2 bayonet locks.** Firm mounting of specula to head.

**Short, closed SANALON S specula
for G100/G100 LED slit illumination head and BETA 100 VET* otoscope**

1 set = 5 veterinary specula in SANALON S	G-000.21.316
40mm long / Ø 2.2mm	G-000.21.310
40mm long / Ø 2.8mm	G-000.21.311
40mm long / Ø 3.5mm	G-000.21.312
40mm long / Ø 4.5mm	G-000.21.313
40mm long / Ø 5.5mm	G-000.21.314

HEINE reusable VET specula



A VET adaptor [01] is required for use on the BETA 100 VET*.

- **Made of high-density SANALON S with a smooth external surface.** Dust and germs are easily removed. Disinfection and autoclaving at up to 134 °C is possible.
- **Ergonomic shape.** Atraumatic.
- **Convenient fixation system.** Positive fit to otoscope head.

**Reusable SANALON S specula
for BETA 200 VET and BETA 100 VET* with adaptor**

1 set = 3 reusable SANALON S specula	G-000.21.213
61 mm long / Ø 4mm	G-000.21.210
61 mm long / Ø 6mm	G-000.21.211
61 mm long / Ø 9mm	G-000.21.212

Adaptor for reusable SANALON S VET specula [01]	G-000.21.214
---	--------------

* instrument no longer available

HEINE UniSpec® disposable specula



The adaptor illustrated [01] is necessary when using UniSpec specula with the G100/G100 LED slit illumination head.

- ∴ **No cleaning necessary.** Saves time.
- ∴ **Hygienic and safe.** Eliminates cross-infection.
- ∴ **Packed in units of 1000.** Assures a competitive price.
- ∴ **Original HEINE design and manufacture.** Guaranteed good fit to the instrument head.

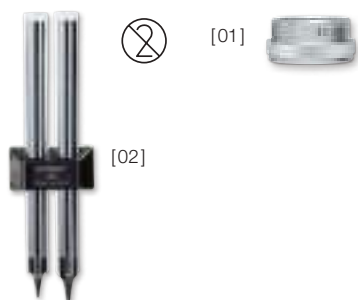

UniSpec disposable specula

for BETA 100 VET*, operating otoscope* and G100/G100 LED slit illumination head

Pack of 1000 UniSpec disposable specula Ø 2.5mm	B-000.11.242
Pack of 1000 UniSpec disposable specula Ø 4mm	B-000.11.241

Adaptor for use with slit illumination head [01]	G-000.21.302
UniSpec tip dispenser	B-000.11.146

⊗: Single use only.

Further articles / accessories

HEINE veterinary ENT diagnostic instruments

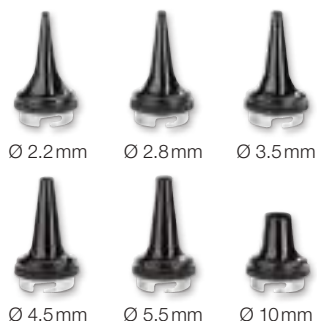

Reusable specula for operating otoscope*

1 set = 5 ear specula and 1 nose speculum	B-000.11.221
3 specula Ø 3.5/4.5/5.5mm	B-000.11.222
Ear speculum Ø 2.2mm	B-000.11.215
Ear speculum Ø 2.8mm	B-000.11.216
Ear speculum Ø 3.5mm	B-000.11.217
Ear speculum Ø 4.5mm	B-000.11.218
Ear speculum Ø 5.5mm	B-000.11.219
Nose speculum Ø 10mm	B-000.11.220



AllSpec disposable tips for BETA 100 VET* and operating otoscope*

Pack of 1000 pcs. Ø 2.5mm [01]	B-000.11.128
Pack of 1000 pcs. Ø 4mm [01]	B-000.11.127
Case of 10 packs of 1000 pcs, Ø 2,5mm	B-000.11.138
Case of 10 packs of 1000 pcs, Ø 4mm	B-000.11.137



Dispenser pack, single, of 250 tips, Ø 2.5mm [02]	B-000.11.153
Dispenser pack, single, of 250 tips, Ø 4mm [02]	B-000.11.152
Case of 10 dispenser packs of 250 tips, Ø 2.5mm	B-000.11.151
Case of 10 dispenser packs of 250 tips, Ø 4mm	B-000.11.150



Adaptor for AllSpec tips [03]	B-000.11.306
-------------------------------	---------------------

AllSpec tip-dispenser (2x 50 tips) [04]	B-000.11.149
---	---------------------

⊗: Single use only.

* instrument no longer available

Further articles / accessories

HEINE veterinary ENT diagnostic instruments

G100 slit illumination head	2.5V XHL	3.5V XHL	LED
with swivel lens, without handle	G-001.21.301	G-002.21.301	G-008.21.301



BETA 200 VET F.O. otoscope head	2.5V XHL	3.5V XHL	LED
without handle and without accessories	G-001.21.250	G-002.21.250	G-008.21.250



Spare bulb for G100 and BETA 200 VET	2.5V XHL	3.5V XHL
XHL xenon halogen spare bulb	X-001.88.077	X-002.88.078



Spare bulb for operating otoscope* and BETA 100 VET*	2.5V XHL	3.5V XHL
XHL xenon halogen spare bulb	X-001.88.037	X-002.88.049



Swivel lens for G100 slit illumination head	
Swivel lens, single	G-000.21.209



Insufflation bulb for pneumatic testing	
Insufflation bulb for BETA 200 VET and BETA 100 VET* otoscopes	B-000.11.240

* instrument no longer available



High-quality fiber optics (F.O.) provide a homogeneous, reflex-free illumination.

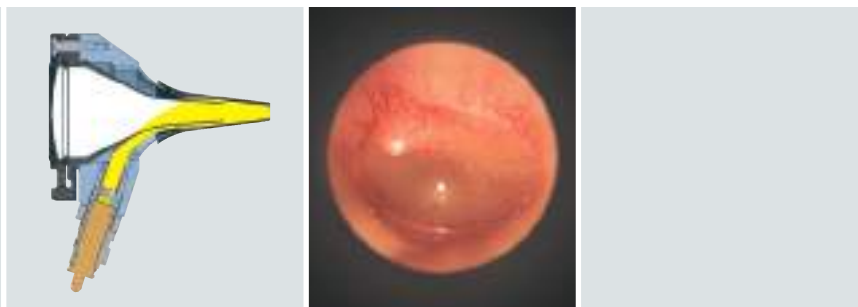

HEINE BETA® 400 LED F.O. otoscope

4.2x magnification with LED^{HQ} illumination



The otoscope has been designed with an all metal housing and scratch resistant glass lenses which guarantee a lifetime of maintenance-free use. LED with virtually unlimited hours of working life. No need to ever replace bulbs. Maintenance-free for a lifetime.



- ∴ **Exclusive 4.2x magnification.** More detail of anatomical structures and easy recognition of foreign bodies.
- ∴ **Exceptional depth of field.** Provides sharp spatial images in a convenient working range.
- ∴ **Large field of view.** Gives the necessary overview and perfect orientation during examinations.
- ∴ **Multi-coated precision optics.** Offer high resolution and distortion free images.
- ∴ **Fiber optic illumination.** Ensures homogeneous, very bright illumination and an unobstructed view of the ear canal and tympanum.
- ∴ **There's LED. And there's LED^{HQ}.** HEINE has set a new standard which maintains that only the best is good enough, from the selection of materials to processing, from light intensity to dimmability, and from thermal management to a colour rendering index as high as possible. **That's what we call LED in HEINE Quality – or LED^{HQ}.**
- ∴ **Special optical interface to precisely integrate the LED illumination with the optical system** to ensure bright, homogeneous light during examinations.
- ∴ **Patented, unique, stepless dimming** from 3% to 100% with practical one-finger operation.
- ∴ **One hand operation.** The unique patented design allows the permanently attached optical system to be flipped open and out of the way, enabling instrumentation and ease of cleaning.
- ∴ **Integrated insufflation port** offers tympanic mobility testing without air leakage.
- ∴ **Full functionality of the BETA 400 LED is guaranteed with BETA rechargeable handles and the EN 200 / EN 200-1 wall transformers.**
- ∴ **Also available with XHL xenon halogen illumination.** Bright illumination and authentic colour rendering; for other technical specifications see BETA 400 LED F.O. otoscope.
- ∴ **A tip for a better future.** HEINE AllSpec disposable tips – made of recycled plastic. Read more on page 008.



BETA 400 F.O. otoscope head	2.5V XHL	3.5V XHL	LED
with 4 reusable tips, without handle	B-001.11.401	B-002.11.401	B-008.11.401
without handle and without accessories	B-001.11.400	B-002.11.400	B-008.11.400

Spare bulb for BETA 400 and BETA 200	2.5V XHL	3.5V XHL
XHL xenon halogen spare bulb	X-001.88.077	X-002.88.078



HEINE BETA® 200 LED F.O. otoscope

Sharpest images, perfect colour rendering and brightness in LED^{HQ}

LED^{HQ}
 LED IN HEINE QUALITY.



The otoscope has been designed with an all metal housing and scratch resistant glass lenses which guarantee a lifetime of maintenance-free use. LED with virtually unlimited hours of working life. No need to ever replace bulbs. Maintenance-free for a lifetime.

- ∴ **3x magnification.** The multi-coated glass viewing window offers high resolution and distortion-free images.
- ∴ **Fiber optic illumination.** Ensures homogeneous, very bright illumination and an unobstructed view of the ear canal and tympanum.
- ∴ **There's LED. And there's LED^{HQ}.** HEINE has set a new standard which maintains that only the best is good enough, from the selection of materials to processing, from light intensity to dimmability, and from thermal management to a colour rendering index as high as possible. **That's what we call LED in HEINE Quality – or LED^{HQ}.**
- ∴ **Special optical interface to precisely integrate the LED illumination with the optical system** to ensure bright, homogeneous light during examinations.
- ∴ **Patented, unique, stepless dimming** from 3% to 100% with practical one-finger operation.
- ∴ **Viewing window is permanently attached**, and swivels for instrument use and complete cleaning of the instrument head.
- ∴ **Integrated insufflation port** offers tympanic mobility testing without air leakage.
- ∴ **Full functionality of the BETA 200 LED is guaranteed with BETA rechargeable handles and the EN 200 / EN 200-1 wall transformers.**

- ∴ **Also available with XHL xenon halogen illumination.** Bright illumination and authentic colour rendering; for other technical specifications see BETA 200 LED F.O. otoscope.

- ∴ **A tip for a better future.** HEINE AllSpec disposable tips – made of recycled plastic. Read more on page 008.



BETA 200 F.O. otoscope head	2.5V XHL	3.5V XHL	LED
with 4 reusable tips, without handle	B-001.11.501	B-002.11.501	B-008.11.501
without handle and without accessories	B-001.11.500	B-002.11.500	B-008.11.500

Spare bulb for BETA 400 and BETA 200	2.5V XHL	3.5V XHL
XHL xenon halogen spare bulb	X-001.88.077	X-002.88.078



HEINE mini 3000® F.O. otoscope

Compact pocket otoscope with XHL or LED^{HQ} illumination



Modern pocket otoscope with bright illumination and accurate colour rendering. Unique design, compact and powerful. Can only be used with the mini 3000 handle system. Available in black or blue.



Features for both instruments (XHL and LED):

- ∴ **20,000 ON/OFF** switch cycles guaranteed.
- ∴ **Distal fiber optic (F.O.) illumination:** Reflex-free illumination of tympanum and ear canal.
- ∴ **Viewing window with 3x magnification and** optimized casing surface for razor-sharp images and minimal reflection. Swivelling viewing window built into instrument.
- ∴ **Pneumatic testing** of tympanum mobility by using the insufflation port and an optional connector.
- ∴ **Attachment clip with integrated on/off switch.** Switches off automatically when returned to the pocket.
- ∴ **Replaceable batteries.** Size AA, or optional rechargeable battery with mini NT table charger.*
- ∴ **2-piece handle and head.** Easy to maintain, flexible.
- ∴ **Award-winning design.** Maximum quality with minimum dimensions.

- ∴ **A tip for a better future.** HEINE AllSpec disposable tips – made of recycled plastic. Read more on page 008.

Special features of the LED instruments:

- ∴ **Maintenance-free,** no need to ever exchange the LED.
- ∴ LED thermal management for a **consistent light output throughout the whole working life.**
- ∴ **There's LED. And there's LED^{HQ}.** HEINE has set a new standard which maintains that only the best is good enough, from the selection of materials to processing, from light intensity and thermal management to a colour rendering index as high as possible. **That's what we call LED in HEINE Quality – or LED^{HQ}.**
- ∴ **Twice as bright as** xenon halogen instruments.
- ∴ **Exclusive battery performance indicator:** When the instrument is switched on, the maximum light intensity is shown, then the light intensity is regulated down to the level that corresponds to the current charge status of the battery so you know when your batteries need changing.
- ∴ **Fade-out feature:** brightness reduces slowly even with low residual capacity, for even more efficient use of dry or rechargeable batteries.
- ∴ **Operating time typ. 10 hours.** The batteries need to be changed less often and the rechargeable batteries last longer.



mini 3000 F.O. otoscope head	2.5V XHL	2.5V LED
without handle and without accessories *	D-001.70.106	D-008.70.106

* Available in black or blue. Please specify the colour you prefer when ordering. If not otherwise specified, we will supply black instruments.

Spare bulb for mini 3000 F.O.	2.5V XHL
XHL xenon halogen spare bulb	X-001.88.105



HEINE mini 3000 F.O. diagnostic sets/kits



[01]

Set/kit includes: mini 3000 F.O. otoscope,

1 set (4 pcs.) of reusable tips, 10 AllSpec disposable tips 4 mm Ø

Optionally with or without hard case.

	2.5V XHL	2.5V LED
mini 3000 battery handle with batteries, hard case [01]	D-851.10.021	D-885.20.021
mini 3000 battery handle with batteries, without case	D-001.70.120	D-008.70.120



[02]

Without case

Kit includes: mini 3000 F.O. otoscope,

10 AllSpec disposable tips 4 mm Ø

	2.5V XHL	2.5V LED
mini 3000 battery handle with batteries [02]	D-001.70.110	D-008.70.110



Set includes: mini 3000 F.O. otoscope and mini 3000 ophthalmoscope,

1 set (4 pcs.) of reusable tips, 10 AllSpec disposable tips 4 mm Ø,

hard case.

	2.5V XHL	2.5V LED
2 mini 3000 battery handles with batteries	D-873.11.021	D-886.11.021

∴ For further information on the HEINE mini 3000 ophthalmoscope, please see page 025.

HEINE AllSpec® disposable tips

Made of recycled plastic



Ø 2.5mm Ø 4mm



[01]



[02]



[03]

- ∴ The renowned **HEINE Quality** is now saving tons of CO₂.
- ∴ For a particularly secure fit, best light transmission and hygiene.
- ∴ **Assured quality.** No sharp edges.
- ∴ Read about what else we're doing for the environment here: www.heine.com

AllSpec disposable tips

for BETA 400, BETA 200, mini 3000 F.O., mini 3000 otoscopes

Pack of 1000 pcs. Ø 2.5 mm [01]	B-000.11.128
Pack of 1000 pcs. Ø 4 mm [01]	B-000.11.127
Case of 10 packs of 1000 pcs, Ø 2,5 mm	B-000.11.138
Case of 10 packs of 1000 pcs, Ø 4 mm	B-000.11.137

Dispenser pack, single, of 250 tips, Ø 2.5 mm [02]	B-000.11.153
Dispenser pack, single, of 250 tips, Ø 4 mm [02]	B-000.11.152
Case of 10 dispenser packs of 250 tips, Ø 2.5 mm	B-000.11.151
Case of 10 dispenser packs of 250 tips, Ø 4 mm	B-000.11.150

- ∴ **AllSpec tip dispenser** incl. tips Ø 2.5mm and 4mm.
The right size, visible and instantly available. A clean new tip for each and every patient.

AllSpec tip dispenser (2 x 50 tips) [03]	B-000.11.149
--	---------------------

⊗: Single use only.

Reusable tips

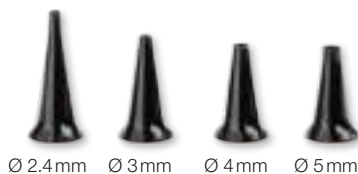

Ø 2.4mm Ø 3mm Ø 4mm Ø 5mm

- ∴ For the most secure fit, best light transmission and hygiene, we recommend the use of **HEINE otoscope tips**.
- ∴ **Made of high-density SANALON S plastic with smooth external finish.** Easy to clean. Common germicides can be used. Autoclavable at up to 134 °C.
- ∴ **Ergonomic shape.** Painless atraumatic insertion.

Reusable tips

for BETA 400, BETA 200, mini 3000 F.O., mini 3000 otoscopes

	1 piece	50 pieces
Reusable tip Ø 2.4mm	B-000.11.107	B-000.11.207
Reusable tip Ø 3.0mm	B-000.11.108	B-000.11.208
Reusable tip Ø 4.0mm	B-000.11.109	B-000.11.209
Reusable tip Ø 5.0mm	B-000.11.110	B-000.11.210

1 set = 4 pcs. reusable tips SANALON S Ø 2.4/3/4/5mm	B-000.11.111
--	---------------------



Bright XHL xenon halogen direct illumination.

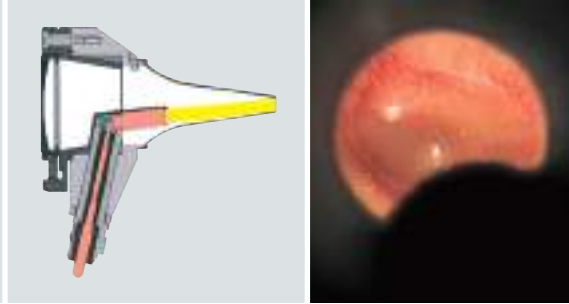

HEINE mini 3000® otoscope

Compact pocket otoscope with direct illumination



Modern pocket otoscope in a unique, compact design. Can only be used with the mini 3000 handle system. Available in black or blue.

- ∴ **Instrument head matt-black inside.** Eliminates reflexes.
- ∴ **Enhanced XHL xenon halogen technology with 100% more light compared with conventional bulbs.** Very bright, concentrated white light for perfect illumination.
- ∴ **2-piece handle and head.** Easy to maintain, flexible. Compatible with other mini 3000 instrument heads.
- ∴ **Viewing window with 3x magnification** and optimised casing surface for razor-sharp images and minimal reflection.
- ∴ **Swivelling viewing window built into instrument.** Useful for instrumentation, cannot be mislaid.
- ∴ **High-quality handle: Chrome-finished upper section/refined plastic.** Shockproof, sturdy, non-slip.
- ∴ **Attachment clip with integrated on/off switch.** Secure. Switches off automatically when returned to the pocket. 20,000 switch cycles guaranteed.
- ∴ **Replaceable batteries.** Size AA, or optional rechargeable battery with mini NT table charger*.

- ∴ **A tip for a better future.** HEINE AllSpec disposable tips – made of recycled plastic. Read more on page 008.



mini 3000 otoscope head	2.5V XHL
without handle and without accessories *	D-001.70.206

*Available in black or blue. Please specify the colour you prefer when ordering. If not otherwise specified, we will supply black instruments.

Spare bulb for mini 3000	2.5V XHL
XHL xenon halogen spare bulb	X-001.88.110



HEINE mini 3000 diagnostic sets/kits



[01]



[02]

Without case

Set/kit includes: mini 3000 otoscope,
 1 set (4 pcs.) reusable tips, 10 AllSpec disposable tips 4 mm Ø

	2.5V XHL
mini 3000 battery handle with batteries, hard case [01]	D-851.20.021
mini 3000 battery handle with batteries, without case [02]	D-001.70.220
mini 3000 battery handle with batteries, without case, without reusable tips	D-001.70.210



Set includes: mini 3000 otoscope, mini 3000 ophthalmoscope,
 1 set (4 pcs.) reusable tips, 10 AllSpec disposable tips 4 mm Ø, hard case.

	2.5V XHL
2 mini 3000 battery handles with batteries	D-873.21.021

∴ For further information on the HEINE mini 3000 ophthalmoscope, please see page 025.



Further articles / accessories

HEINE otoscopes



Replacement aperture cover for BETA 100* and K100*

Aperture cover for bulb, reduces reflexes

B-000.11.212



Spare bulb for BETA 100* and K100*

2.5V XHL

3.5V XHL

XHL xenon halogen spare bulb

X-001.88.037

X-002.88.049



Tip adaptor for BETA 100* and K100*

Adaptor for AllSpec disposable tips (p.008) for use with diagnostic otoscope (BETA 100, K100)

B-000.11.306



Insufflation bulb for BETA 100* and K100*

Insufflation bulb for pneumatic testing

B-000.11.240



Ø 2.2mm



Ø 2.8mm



Ø 3.5mm



Ø 4.5mm



Ø 5.5mm



Ø 10mm

Reusable specula for BETA 100* and K100*

1 set = 5 ear specula and 1 nose speculum

B-000.11.221

3 specula Ø 3.5/4.5/5.5mm

B-000.11.222

Ear speculum Ø 2.2mm

B-000.11.215

Ear speculum Ø 2.8mm

B-000.11.216

Ear speculum Ø 3.5mm

B-000.11.217

Ear speculum Ø 4.5mm

B-000.11.218

Ear speculum Ø 5.5mm

B-000.11.219

Nose speculum Ø 10mm

B-000.11.220



Ø 2.5mm



Ø 4mm



UniSpec disposable specula for BETA 100* and K100*

Pack of 1000, Ø 2.5mm (infants) 1000 pcs./1 pack

B-000.11.242

Pack of 1000, Ø 4mm (adults) 1000 pcs./1 pack

B-000.11.241

UniSpec tip dispenser

B-000.11.146

⊗: Single use only.

* instrument no longer available



Further articles / accessories

HEINE tongue-blade holder



Tongue-blade holder head for wooden tongue-blades	2.5V XHL	3.5V XHL
without handle and without accessories	B-001.12.302	B-002.12.302



Tongue-blade holder head for disposable tongue-blades	2.5V XHL	3.5V XHL
without handle and without accessories	B-001.12.305	B-002.12.305



mini 3000 tongue-blade holder head	2.5V XHL	
without handle and without accessories		D-001.74.100



Spare bulb for tongue-blade holder	2.5V XHL	3.5V XHL
XHL xenon halogen spare bulb	X-001.88.037	X-002.88.049



Replacement light-guide for tongue-blade holder		
Light-guide for bulb		B-000.12.308



Spare bulb for mini 3000 tongue-blade holder	2.5V XHL	
XHL xenon halogen spare bulb	X-001.88.037	



Disposable plastic tongue-blades		
Pack of 100 disposable plastic tongue-blades		B-000.12.304

HEINE mini-c hand-held examination light

With unique LED^{HQ}

LED^{HQ}
LED IN HEINE QUALITY.



Without case

Robust, durable examination light in a compact pocket size.
Bright, concentrated light – with unique LED^{HQ}.

- ∴ **Safe examination of the eyes** due to tested photobiological safety.
- ∴ **Comfortable and ergonomic.**
- ∴ **Natural colours and virtually unlimited operating life of the LED^{HQ}.**
- ∴ **Switches off automatically when placed in the pocket.**
- ∴ **20,000 on/off cycles guaranteed.**
- ∴ **Replaceable batteries** (size: AAA).

LED

mini-c hand-held examination light incl. batteries

D-008.73.109



Ophthalmic instruments





HEINE BETA® 200S LED ophthalmoscope

Superior aspherical optics with LED^{HQ} illumination



Exclusive dustproof design protects the precision optical components and ensures maintenance-free operation. The BETA 200/200S ophthalmoscopes are the only instruments with an aluminium frame system. Optical components are flush-mounted on a cast aluminum frame, eliminating misalignment and making the instrument shock-resistant. The BETA 200S LED has virtually unlimited hours of working life. No need to ever replace bulbs. Maintenance-free for a lifetime.

- ∴ **Exclusive aspherical optical system (AOS).**
- ∴ **There's LED. And there's LED^{HQ}.** HEINE has set a new standard which maintains that only the best is good enough, from the selection of materials to processing, from light intensity to dimmability, and from thermal management to a colour rendering index as high as possible. **That's what we call LED in HEINE Quality – or LED^{HQ}.**
- ∴ **Special optical interface to precisely integrate the LED illumination with the optical system** to ensure bright, homogeneous light during examinations.
- ∴ **The BETA 200S ophthalmoscope** accommodates higher refractive errors with a **28 single lenses rekoss disc** and features a 74 single step design on a non-continuous wheel avoiding extreme diopter jumps.
 - + in 1 D steps: +1 through +38 D
 - in 1 D steps: -1 through -36 D
- ∴ **Patented, unique, stepless dimming** from 3% to 100% with practical one-finger operation.
- ∴ **No stray light due to the recessed, multi-coated viewing window** – eliminates distractions.
- ∴ **Precise one-hand control of the instrument.** Ergonomic design offers flexibility while examining.
- ∴ **Suitable for large as well as small or undilated pupils.**
- ∴ **Ergonomic design** fits the orbita comfortably, and blocks out ambient light.
- ∴ **Full functionality of the BETA 200S LED is guaranteed with BETA rechargeable handles and the EN 200 / EN 200-1 wall transformers.**

BETA 200S with 7 apertures



Cobalt blue filter, fixation star with polar coordinates, large spot, small spot, pinhole, slit, hemispot



With red-free filter

- ∴ **Also available with XHL xenon halogen illumination.** Bright illumination and authentic colour rendering; for other technical specifications see BETA 200S LED ophthalmoscope.



BETA 200S ophthalmoscope head	2.5V XHL	3.5V XHL	LED
without handle and without accessories	C-001.30.120	C-002.30.120	C-008.30.120
Spare bulb for BETA 200S, BETA 200 and BETA 200 M2	2.5V XHL	3.5V XHL	
XHL xenon halogen spare bulb	X-001.88.069	X-002.88.070	

HEINE BETA® 200 LED ophthalmoscope

Superior aspherical optics with LED^{HQ} illumination



The ophthalmoscope with unique aspherical optics and all features of the BETA 200S LED, but:

- Without macula aperture (pinhole)
- The BETA 200 ophthalmoscope accommodates higher refractive errors with a 27 single lenses rekoss disc.

+ in 1 D steps:	1 – 10	15	20	40	D
- in 1 D steps:	1 – 10	15	20	25	35 D

- Full functionality of the BETA 200 LED is guaranteed with BETA rechargeable handles and the EN 200 / EN 200-1 wall transformers.

- Also available with XHL xenon halogen illumination. Bright illumination and authentic colour rendering; for other technical specifications see BETA 200 LED ophthalmoscope.



BETA200 with 6 apertures



Slit, fixation star with polar coordinates, cobalt blue filter, large spot, small spot, hemislot



With red-free filter



BETA 200 ophthalmoscope head	2.5V XHL	3.5V XHL	LED
without handle and without accessories	C-001.30.100	C-002.30.100	C-008.30.100



BETA 200 M2 ophthalmoscope head	2.5V XHL	3.5V XHL
without handle and without accessories Like BETA 200, except with pinhole instead of small spot and with fixation star aperture without polar coordinates	C-001.30.102	C-002.30.102



Spare bulb for BETA 200S, BETA 200 and BETA 200 M2	2.5V XHL	3.5V XHL
XHL xenon halogen spare bulb	X-001.88.069	X-002.88.070



HEINE K180 ophthalmoscope

Standard direct ophthalmoscope

A full-featured instrument at an economical price.

- ∴ **Precision spherical HEINE optics.** Corneal and iris reflexes are eliminated.
- ∴ **XHL xenon halogen technology.** Bright, white light. Clear retinal image.
- ∴ **Range of lenses: 27 lenses from -35D to +40D.** Brilliant image even at high corrections.

+ in 1 D steps: 1 – 10	15	20	40	D
- in 1 D steps: 1 – 10	15	20	25	35 D

- ∴ **Ergonomical shape.** The instrument fits the orbita comfortably.
- ∴ **Soft orbital rest.** Steadies the instrument and protects your glasses.
- ∴ **Choice of 5 apertures.** For both large and small pupils. Choice of fixation star or cobalt blue filter for corneal examination.
- ∴ **Dust resistant housing.** Maintenance-free.
- ∴ **High-impact polycarbonate housing for durability.**



K180 apertures



Aperture wheel 1:
Slit, red-free filter, fixation star with polar coordinates, large spot, small spot



Aperture wheel 2:
Slit, red-free filter, cobalt blue filter, large spot, small spot



K180 ophthalmoscope head	2.5V XHL	3.5V XHL
with aperture wheel 1, without handle and without accessories	C-001.30.206	C-002.30.206
with aperture wheel 2, without handle and without accessories	C-001.30.207	C-002.30.207
Spare bulb for K180	2.5V XHL	3.5V XHL
XHL xenon halogen spare bulb	X-001.88.084	X-002.88.086

HEINE mini 3000® ophthalmoscope

Compact pocket ophthalmoscope with XHL or LED^{HQ} illumination

LED^{HQ}
 LED IN HEINE QUALITY.



mini 3000 apertures



Fixation star, large spot, small spot, hemispot, red-free filter



Modern pocket ophthalmoscope with concentrated bright light for perfect illumination, a brilliant image and accurate colour rendering. Fixation star aperture with grey filter for reducing the light intensity. Excellent optics and best colour rendering in minimum dimensions, ideal for rounds and house calls. Can be used with the mini 3000 handle system. Available in black and blue.

Features for both instruments (XHL and LED):

- **HEINE optics produce crisp, clear images of the whole area under examination** and minimise reflections.
 - **5 different apertures.** A full-function instrument incl. fixation star.
 - Grey filter for light-sensitive patients.
 - **Range of lenses: 18 lenses from -20 D to +20 D.**
- | | | | | | | | | | |
|---|---|---|---|---|---|---|----|----|-----|
| + | 1 | 2 | 3 | 4 | 6 | 8 | 10 | 15 | 20D |
| - | 1 | 2 | 3 | 4 | 6 | 8 | 10 | 15 | 20D |
- **Easy workflow**, because ophthalmoscopy is possible without dilation of the pupils.
 - **Attachment clip with integrated on/off switch.** Switches off automatically when returned to the pocket.
 - **Replaceable batteries.** Size AA, or optional rechargeable battery with mini NT table charger.*
 - **2-piece handle and head.** Easy to maintain, flexible.
 - **Award-winning design.** Maximum quality with minimum dimensions.

Special features of the LED instruments:

- **Maintenance-free**, no need to ever replace the LED.
- LED Thermal management for a **consistent light output throughout the whole working life.**
- **There's LED. And there's LED^{HQ}.** HEINE has set a new standard which maintains that only the best is good enough, from the selection of materials to processing, from light intensity and thermal management to a colour rendering index as high as possible. **That's what we call LED in HEINE Quality – or LED^{HQ}.**
- **Exclusive battery performance indicator:** When the instrument is switched on, the maximum light intensity is shown, then the light intensity is regulated down to the level that corresponds to the current charge status of the battery so you know when your batteries need changing.
- **Fade-out feature:** brightness reduces slowly even with low residual capacity, for even more efficient use of dry or rechargeable batteries.
- **Operation time typ. 10 hours.** The batteries need to be changed less often and the rechargeable batteries last longer.



mini 3000 ophthalmoscope head	2.5V XHL	2.5V LED
without handle and without accessories *	D-001.71.105	D-008.71.105
Spare bulb for mini 3000	2.5V XHL	
XHL xenon halogen spare bulb	X-001.88.106	

*Available in black and blue. Please specify the colour you prefer when ordering. If not otherwise specified, we will supply black instruments.



HEINE mini 3000 diagnostic sets/kits



Set includes: mini 3000 ophthalmoscope, hard case.

	2.5V XHL	2.5V LED
mini 3000 battery handle with batteries	D-852.10.021	D-885.21.021



Without case

mini 3000 ophthalmoscope with	2.5V XHL	2.5V LED
mini 3000 battery handle with batteries	D-001.71.120	D-008.71.120



Set/kit includes: mini 3000 ophthalmoscope, mini 3000 F.O. otoscope,
 1 set (4 pcs.) of reusable tips, 10 AllSpec disposable tips 4 mm Ø

	2.5V XHL	2.5V LED
2 mini 3000 battery handles with batteries with hard case	D-873.11.021	D-886.11.021

∴ For further information on the HEINE mini 3000 F.O. otoscope, please see page 013.



Set includes: mini 3000 ophthalmoscope, mini 3000 otoscope,
 1 set (4 pcs.) of reusable tips, 10 AllSpec disposable tips 4 mm Ø

	2.5V XHL
2 mini 3000 battery handles with batteries with hard case	D-873.21.021

∴ For further information on the HEINE mini 3000 otoscope, please see page 016.

HEINE HSL 150 hand-held slit lamp

For the examination of the anterior segment



Compact and lightweight, the portable HSL 150 is ideal for situations where a full-size slit lamp is not available or convenient.

- ∴ **Slit size adjustable** from 0.2 mm x 10 mm to 4 mm x 14 mm.
- ∴ **6x magnification.**
- ∴ **Blue interference filter (FITC)**, can be selected for corneal examination.
- ∴ **Multi-coated optics for maximum light transmission.**
- ∴ **2.5V or 3.5V XHL xenon halogen technology** for bright, white light comparable with the brightness of a classic slit lamp.
- ∴ **The HSL 150 instrument head weighs just 70 g**, the lightest slit lamp of its kind.



HSL 150 hand-held slit lamp head	2.5V XHL	3.5V XHL
without handle	C-001.14.602	C-002.14.602

HSL 10x loupe attachment for HSL 150		
Loupe attachment with 10x magnification, without instrument	C-000.14.606	

Spare bulb for HSL 150 hand-held slit lamp	2.5V XHL	3.5V XHL
XHL xenon halogen spare bulb	X-001.88.098	X-002.88.099



HEINE ophthalmic examination lamp

For examination of the anterior segment and cornea in focal light



- ∴ **Small and light. Ideal for house calls and rounds.**
- ∴ **5 different apertures.** Helps detect erosion, edema and foreign bodies on the cornea.
- ∴ **Apertures focused at 100mm working distance.**

Aperture combination



Slit, three different spots,
cobalt blue filter for fluorescence examination



Ophthalmic examination lamp head	2.5V XHL	3.5V XHL
without handle	C-001.14.400	C-002.14.400

Spare bulb for ophthalmic examination lamp	2.5V XHL	3.5V XHL
XHL xenon halogen spare bulb	X-001.88.032	X-002.88.047

HEINE Finoff transilluminator

For scleral transillumination



∴ **Detachable cobalt blue filter.** Suitable for fluorescence examinations.

Finoff transilluminator with	LED
BETA4 USB rechargeable handle with USB cord and plug-in power supply	C-019.27.388
BETA4 NT rechargeable handle (without NT4 table charger)	C-019.23.396



Finoff transilluminator head	LED
Finoff for scleral transillumination, without handle [01]	C-002.17.080



Aperture for Finoff transilluminator	
Aperture with cobalt blue filter for Finoff transilluminator	C-000.17.081
Spare bulb for Finoff transilluminator	3.5V XHL
XHL xenon halogen spare bulb	X-002.88.078



HEINE OMEGA® 600 indirect ophthalmoscope

Discover more. With less weight.



Red-free, yellow and cobalt blue filters



Diffuser HEINE, small spot, medium and large



HEINE OMEGA 600 operation film



[01]



[02]



[03]



[04]



[05]



[06]

The lightest high-end indirect ophthalmoscope worldwide

- ∴ Best wearing comfort
- ∴ Personalized fit
 - Ergonomic positioning of controls and levers
 - Adaptable for right and left handed users
 - Flip-up optics unit

Most precise diagnostic, up to the far retinal periphery

- ∴ Significantly better diagnostics due to unique visionBOOST – even in dense cataracts
- ∴ Sharpest fundus image due to superior glass optics
- ∴ Brightest fundus image with true colour rendering thanks to our unique LEDHQ – now in even more natural colours
- ∴ Best 3D imaging due to our unique Stereoscopic Adjustment technology
 - in dilated and undilated pupils
 - even with prematures and newborns

Long-lasting investment due to its robust design

- ∴ Maintenance-free, dustproof optics
- ∴ Legendary HEINE durability
- ∴ 5-year guarantee

Easy and effective disinfection thanks to smoothSURFACE

- ∴ No openings
- ∴ Integrated electronics



Flip-up function of the optics unit
For more convenient patient interactions



***Eyepieces**
To best accommodate your view, exchange the initially mounted eyepieces +2D with the neutral lenses 0D (supplied with the instrument)



Width adjustment

OMEGA 600 sets	LED
OMEGA 600 wall charger set: Indirect ophthalmoscope (with battery and +2D eyepiece), [01], E4-USBC [02], eyepiece 0D*, CW1 wall charger [03]	C-008.33.612
OMEGA 600 traveller set: Indirect ophthalmoscope (with battery and +2D eyepiece) E4-USBC, eyepiece 0D*, traveller bag [04]	C-008.33.613
OMEGA 600 student set: Indirect ophthalmoscope (with battery and +2D eyepiece), E4-USBC, eyepiece 0D*, TM2 teaching mirror [05], traveller bag	C-008.33.614
OMEGA 600 charging set: CC1 charging case, CB1 charging battery [06]	X-000.99.090

Further articles / accessories

HEINE OMEGA 600

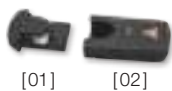

OMEGA 600 ophthalmoscope	LED
with battery and +2D eyepiece, E4-USBC, eyepiece 0D*	C-008.33.610

***Eyepieces:** To best accommodate your view, you can exchange the initially mounted eyepieces +2D with the neutral lenses 0D (supplied with the instrument).

Accessories OMEGA 600 ophthalmoscope	
CC1 charging case [02]	X-000.99.091
CB1 charging battery [01]	X-007.99.687
E4-USBC power supply with cable [03]	X-000.99.300
CW1 wall charger (without OMEGA 600) [04]	X-095.17.320
TM2 teaching mirror [05]	C-000.33.212
OMEGA 600 traveller bag [06] (can be worn over the shoulder or as a backpack.)	C-080.00.000

For further information on the HEINE power sources see page 058.

HEINE A.R. aspheric ophthalmoscopy lenses

With anti-reflex A.R. coating



- ∴ **Advanced triple multicoating.** Reduced reflection, excellent light transmission.
- ∴ **Lens curvature matches that of the retina.** Perfect, distortion-free retinal image.
- ∴ **Large diameter.** Significant increase in field of view without magnification loss.
- ∴ **Aspheric surfaces.** Reduced distortion of the periphery.

Ophthalmoscopy lens with case	
A.R. 16D, Ø 54mm	C-000.17.225
A.R. 20D, Ø 50mm	C-000.17.228
A.R. 30D, Ø 46mm	C-000.17.231

The first part of the document discusses the importance of maintaining accurate records of all transactions. It emphasizes that every sale, purchase, and transfer must be properly documented to ensure compliance with tax laws and to provide a clear audit trail. This includes recording the date, amount, and nature of each transaction, as well as the names of the parties involved.

Additionally, the document highlights the need for regular reconciliation of accounts. By comparing the company's internal records with bank statements and other external sources, discrepancies can be identified and corrected promptly. This practice helps to prevent errors and ensures that the financial statements are accurate and reliable.

Furthermore, the document stresses the importance of staying up-to-date with changes in tax regulations. Tax laws are constantly evolving, and businesses must be proactive in monitoring these changes to ensure they are always in compliance. This may involve consulting with a tax professional or staying informed through industry publications and seminars.

In conclusion, maintaining accurate records and staying current with tax regulations are essential for the success and longevity of any business. By following these guidelines, businesses can minimize the risk of penalties and ensure that they are always in good standing with the tax authorities.

| Laryngoscopes

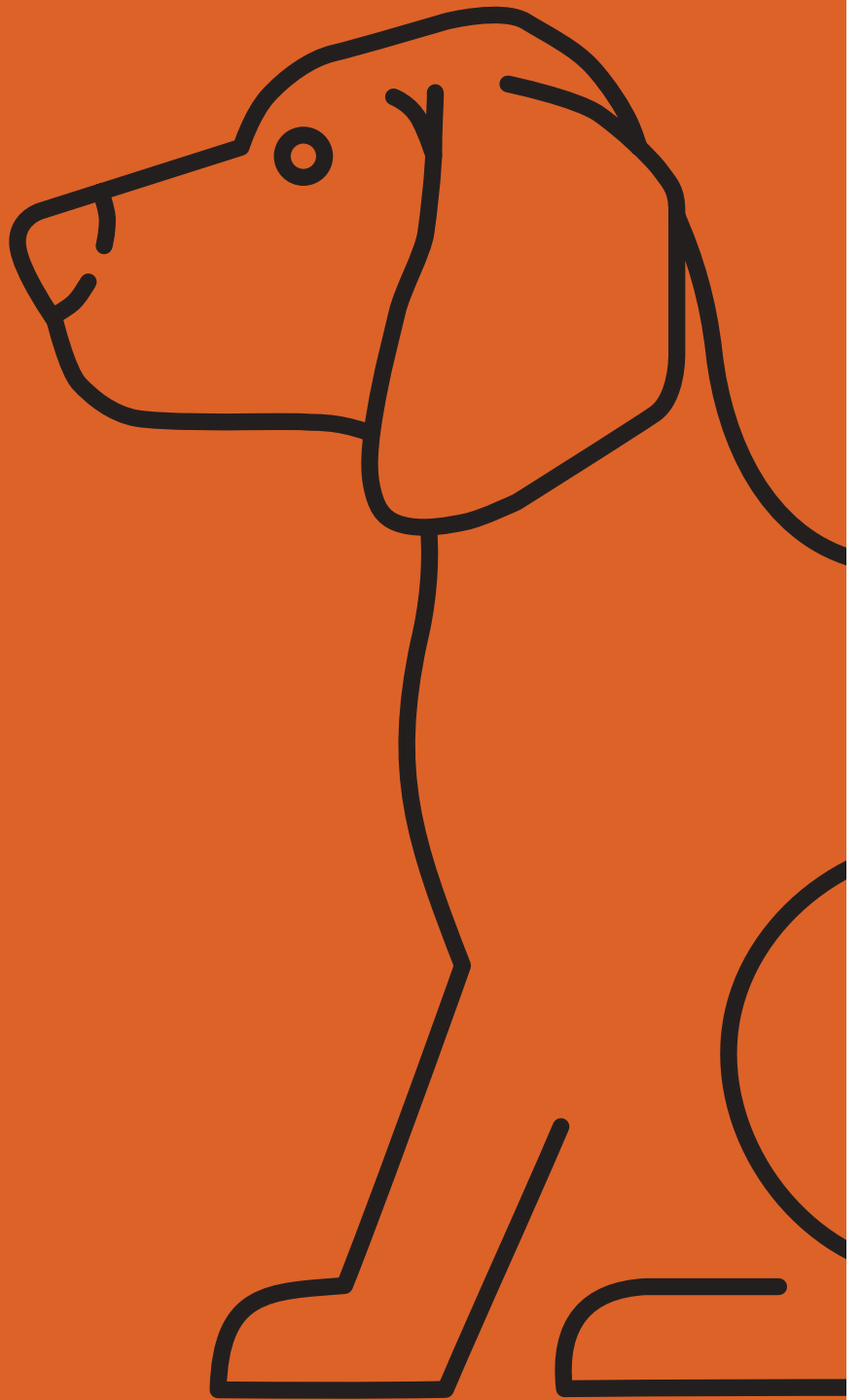



HEINE visionPRO video laryngoscope

With very, very, very good image quality



allBRIGHT

For fast and reliable intubation, nothing is more important than the best view of the glottis. The new HEINE visionPRO video laryngoscope provides just that with the new and one of a kind HEINE allBRIGHT display – even in very bright ambient light. At the same time, the new HEINE visionPRO is extremely robust, reliable and durable. To be as environmentally friendly as possible, we chose a rechargeable lithium battery and are the first to provide a blade made from upcycled material.

Bright and sharp image

- ⋄ Unique worldwide: HEINE transfective allBRIGHT display adapts to even the brightest ambient light
- ⋄ Excellent 3.2" display in practical portrait format
- ⋄ Low-reflection intubation thanks to an adjustable display angle
- ⋄ Realistic colour representation thanks to smart image processing
- ⋄ HEINE LED^{HO}

Quick and comprehensive orientation

- ⋄ Situational field of view of the glottis and the relevant surrounding anatomy

Extremely durable and long-lasting

- ⋄ Grip head and display frame made of anodised aluminium
- ⋄ Stainless steel handle and camera arm
- ⋄ Highly protective cover glass

Safe: Display and handle can be separated for numerous validated reprocessing methods

- ⋄ Assembled instrument: low level/wipe disinfection reprocessing
- ⋄ Handle: from wipe disinfection to immersion and sterilisation

Ecological and economical

- ⋄ Blade made from upcycled material
- ⋄ Rechargeable battery vs. disposable batteries
- ⋄ Cost reduction through economic procurement management



HEINE visionPRO videos



HEINE visionPRO Mac 3 single-use laryngoscope blades made from upcycled material



[01]



[02]

visionPRO set Mac	
visionPRO video laryngoscope consisting of visionPRO HR1 Mac handle and visionPRO DS1 display unit, visionPRO CS1 charging station with plug-in power supply [01]	F-270.95.862
visionPRO Mac 3 single-use laryngoscope blades, box of 50	F-000.22.253
visionPRO Mac 4 single-use laryngoscope blades, box of 50	F-000.22.254
visionPRO Mac 3 single-use laryngoscope blades, box of 10 [02]	F-000.22.243
visionPRO Mac 4 single-use laryngoscope blades, box of 10	F-000.22.244

HEINE Classic+ Macintosh fiber optic (F.O.) blades

Innovative fiber optic technology for advanced performance

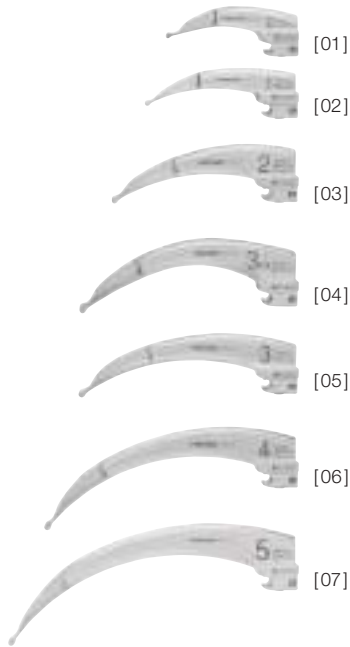

Our innovative manufacturing technology achieves even better illumination and a longer service life.

- ∴ **The HEINE HiLite fiber optic (F.O.) fiber bundle, optimised for use** with up to 6,500 individual fibers and refined directional characteristics, achieves the best possible illumination of the pharynx even after 4,000 sterilisation cycles. For simple and safe intubation.
- ∴ **The one-piece design from chrome-plated, stainless, high-grade steel** makes the Classic+ F.O. blade even more resistant to the oxidation and/or corrosion damage that can occur in the reprocessing process due to intense use.
- ∴ **HEINE Classic+ blades have no screwed joints, no external fiber bundles and no openings** that could contaminate.
- ∴ **The clean shape without any edges or corners** is easy to clean, disinfect and sterilise.
- ∴ **Compatible with all handles** to the ISO 7376 (green standard).
- ∴ **10 years guarantee.** After 4000 autoclave cycles of 134 °C/4 min, illuminance of at least 1,000 lux.

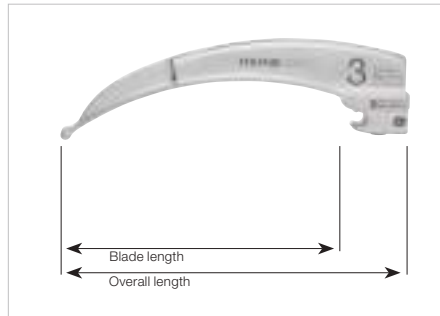

Size	Overall length	Blade length	Distal width	
Mac 0 [01]	82 mm	66 mm	9 mm	F-000.22.100
Mac 1 [02]	94 mm	78 mm	10 mm	F-000.22.101
Mac 2 [03]	114 mm	98 mm	14 mm	F-000.22.102
Mac 3m* [04]	134 mm	118 mm	14 mm	F-000.22.143
Mac 3 [05]	134 mm	118 mm	14 mm	F-000.22.103
Mac 4 [06]	155 mm	139 mm	15 mm	F-000.22.104
Mac 5 [07]	177 mm	161 mm	15 mm	F-000.22.105

* stronger curve

HEINE Classic+ Miller fiber optic (F.O.) blades

Innovative fiber optic technology for advanced performance

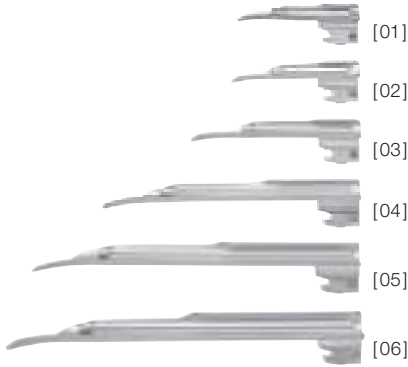

- ∴ **The Miller Classic+ blades with improved geometry simplify intubation.**
The shortened shoulder of the blade dramatically improves the anesthetist's view of the epiglottis and vocal cords. The distal lip of the blade features a special atraumatic shape.
- ∴ **HEINE HiLite fiber bundle** with up to 6,500 individual micro-fibers for improved light transmission and longer life.
- ∴ **Both ends of the large fiber bundle** are protected – for life.
- ∴ **HEINE Classic+ blades have no screwed joints**, no external fiber bundles and no openings that could contaminate.
- ∴ **The clean shape without any edges or corners** is easy to clean, disinfect and sterilise.
- ∴ These blades need **no maintenance** – ever.
- ∴ **Compatible** with all handles to the ISO 7376 (green standard).
- ∴ **High-quality design from chrome-plated, stainless, high-grade steel.**
- ∴ **10 years guarantee.** After 4000 autoclave cycles of 134 °C / 4 min, illuminance of at least 1,000 lux.

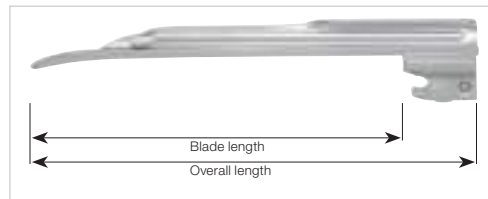

Miller 2 side-view

Size	Overall length	Blade length	Distal width	
Miller 00 [01]	76 mm	51 mm	10 mm	F-000.22.119
Miller 0 [02]	80 mm	55 mm	11 mm	F-000.22.120
Miller 1 [03]	100 mm	78 mm	12 mm	F-000.22.121
Miller 2 [04]	152 mm	130 mm	13 mm	F-000.22.122
Miller 3 [05]	192 mm	170 mm	13 mm	F-000.22.123
Miller 4 [06]	207 mm	185 mm	16 mm	F-000.22.124



HEINE EasyClean® LED laryngoscope handle

All three handle sizes: STANDARD, SLIM AND SHORT



The HEINE EasyClean LED laryngoscope handle was developed to allow even simpler, faster and safer hygienic reprocessing of the handle – no complex disassembling and assembling of batteries and light unit. This saves the technical service personnel a great deal of time, and reduces the training and maintenance effort.

SIMPLE, FAST AND SAFE CLEANING

- **Non-slip “wave design”** improves the reliability of the wipe disinfectant for the handle after use (‘intermediate disinfection’).
- **100% waterproof.** In the case of immersion disinfection (‘high-level disinfection’) or low temperature sterilisation processes (STERRAD®, VHP® (Steris)), neither the batteries nor the LED light unit need to be removed.
- **Autoclavable LED technology:** No removal of the light unit required for use in autoclaves, just batteries.

PERFECT VIEW

- **There’s LED. And there’s LED^{HQ}.** HEINE has set a new standard which maintains that only the best is good enough, from the selection of materials to processing, from light intensity and thermal management to a colour rendering index as high as possible. **That’s what we call LED in HEINE Quality – or LED^{HQ}.**
- **Maximum brightness:** 3x brighter than conventional halogen light.
- Virtually **unlimited hours of working life.**

FAIL-SAFE

- **Typ. 10 hours of operating time** (EasyClean LED laryngoscope handle in continuous operation).
- **Fade-out feature:** brightness reduces slowly as battery operating time diminishes, for even more efficient battery use.
- **Compatible with all laryngoscope blades** according to ISO 7376 (green standard).



[01]

[02]

[03]

EasyClean LED laryngoscope handle	LED
EasyClean LED laryngoscope handle suitable for 2x C-batteries (LR14), complete* [01]	F-008.22.820
EasyClean LED SLIM laryngoscope handle suitable for 2x AA-batteries (LR6), complete* [02]	F-008.22.821
EasyClean LED SHORT laryngoscope handle, suitable for 3x AAA-batteries (LR03), complete* [03]	F-008.22.822

*Delivery without batteries.

HYGIENIC REPROCESSING OPTIONS:**

Reprocessing process →	Wipe disinfection	Manual immersion disinfection	Low temperature gas plasma sterilisation (STERRAD®/VHP® (Steris))	Mechanical cleaning + disinfection (thermal disinfectant)	Steam sterilisation/ autoclave
Temperature	Cold	< 60°C	< 60°C	max. 93°C	max. 134°C/4 min
with batteries	✓	✓	✓	Batteries removed previously	Batteries removed previously
with HEINE LED	✓	✓	✓	✓	✓

**Detailed cleaning instructions can be found in our instructions for use at www.heine.com



HEINE F.O.4 NT laryngoscope handles

Li-ion in all handle sizes – XHL or LED^{HQ} illumination

- **Compatible with all laryngoscope blades to the ISO 7376 (green standard).**
- **HEINE standard F.O. laryngoscope handles can be converted from battery to rechargeable handles by simply exchanging the bottom insert.**
- **Fade-out feature:** brightness reduces slowly even with low residual capacity, for even more efficient use of dry or rechargeable batteries.
- **There's LED. And there's LED^{HQ}.** HEINE has set a new standard which maintains that only the best is good enough, from the selection of materials to processing, from light intensity and thermal management to a colour rendering index as high as possible. **That's what we call LED in HEINE Quality – or LED^{HQ}.**



Standard F.O.4 NT laryngoscope handle	XHL 3.5V Li-ion	LED 3.5V Li-ion
Standard F.O.4 NT handle, complete [01]	F-007.22.894	F-008.22.894
Rechargeable battery [02]	X-007.99.383	X-007.99.383
Spare bulb	X-002.88.044	-

Standard F.O. laryngoscope battery handle	XHL 2.5V	LED 2.5V
Standard F.O. handle, suitable for 2x C-batteries (LR14), compl.** [01]	F-001.22.860	F-008.22.860

F.O.4 SHORT NT laryngoscope handle	XHL 3.5V Li-ion	LED 2.5V Li-ion
F.O.4 SHORT NT handle, complete [01]	F-007.22.424	F-008.22.424
Charging module [02]+[03]	X-007.99.394	X-007.99.304
Spare bulb	X-002.88.044	-

**Delivery without batteries.

Please note: All Li-ion versions can only be charged with the NT4 table charger.

HEINE NT4 table charger and adaptors

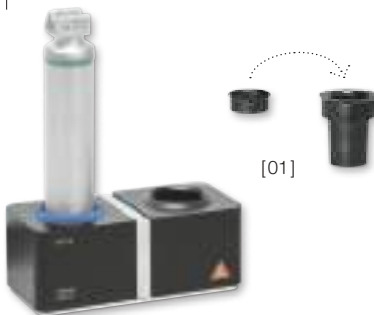

All rechargeable HEINE F.O.4 NT laryngoscope handles can only be charged with the NT4 table charger. The use of an adaptor is required for some handles. For detailed information about the NT4 table charger and adaptor, please see page 056.

NT4 table charger	
without handle, with adaptors for standard F.O.4 NT laryngoscope insert and F.O.4 SHORT NT laryngoscope handle	X-002.99.494
Set of two adaptors for F.O.4 SLIM NT laryngoscope rechargeable handle [01]	X-000.99.086

| Dermatoscopes



HEINE DELTA 30 dermatoscope

Confidence in diagnosis with our most precise imaging



LED IN HEINE QUALITY.



Not only would our high-end dermatoscope win any beauty pageant; it stands out due to the best imaging we've ever developed. Combined with a field of view measuring a veritable 30 millimetres and unprecedented colour rendering, in LED^{HQ} of course. Polarisation provides glare-free and non-reflective working conditions. Above all else, it is comfortable to operate with its angled, ergonomic design and intuitive control.

- ∴ **Largest field of view of real 30mm** (lens 32mm).
- ∴ **Crystal-clear image** with the achromatic HEINE optical system.
- ∴ **Fast change from contact- to non-contact examination.**
- ∴ **Ergonomic handling** thanks to the angled product design.
- ∴ **Operate with just one hand:** individual focusing dioptre compensation approximately -4 to +4 dpt.
- ∴ **Excellent colour rendering** due to LED^{HQ}.
- ∴ **Digital documentation:** Image and data management convenient and intuitive.
More information on our website: www.heine.com/en/digital
- ∴ **Glare-free and non-reflective working conditions** thanks to polarisation.
- ∴ **Custom light intensity:** 3 degrees of luminous intensity.
- ∴ **10x magnification.**
- ∴ **Switch between polarised and non-polarised light at the touch of a button** = toggle function. For more information, please visit heine.com/en/Toggle
- ∴ **No cross-contamination:** autoclavable contact plate with scale.
- ∴ **Maintenance-free** due to our dustproof design.
- ∴ **Rechargeable battery with Li-ion technology:** no memory effect; you can safely recharge the battery regardless of its charge state.

Digital
documentation
by HEINE



HEINE DELTA 30 dermatoscope



DELTA 30 with contact plate with scale, USB cord with medical approved plug-in power supply, hard case [01]

LED

K-230.28.305

Charger 30 table charging station [02]

X-002.99.212

∴ **Accessories can be found on page 042.**

HEINE DELTAone dermatoscope

Uniting diagnostic precision and mobility

LED^{HQ}
LED IN HEINE QUALITY.



[01]

Digital
documentation
by HEINE



Small on the outside, big on the inside. This mobile marvel is taking medical professionals by storm. The crystal-clear image was accomplished using the achromatic HEINE optical system. What's more, it produces extraordinary colour rendering, due to the quality of our LED^{HQ}. Examinations are now particularly comfortable due to the polarisation allowing doctors to work glare-free and without disrupting reflections. These three features – clarity, LED^{HQ} and non-reflective working – plus the small dimensions, naturally, are what turn the DELTAone into a vital working tool wherever you go.

- ∴ **Fits into any pocket.**
- ∴ **Crystal-clear image** with the achromatic HEINE optical system.
- ∴ **Fast change from contact- to non-contact examination.**
- ∴ **Excellent colour rendering** due to LED^{HQ}.
- ∴ **Glare-free and non-reflective working conditions** thanks to polarisation.
- ∴ **Operate with just one hand:** individual focusing dioptre compensation approximately -4 to +4 dpt.
- ∴ **Digital documentation:** Image and data management convenient and intuitive.
More information on our website: www.heine.com/en/digital
- ∴ **Field of view of real 21 mm** (lens 22mm).
- ∴ **Custom light intensity:** 3 degrees of luminous intensity.
- ∴ **10x magnification.**
- ∴ **Switch between polarised and non-polarised light at the touch of a button** = toggle function. For more information, please visit heine.com/en/Toggle
- ∴ **No cross-contamination:** autoclavable contact plate with scale.
- ∴ **Maintenance-free** due to our dustproof design.
- ∴ **Rechargeable battery with Li-ion technology:** no memory effect; you can safely recharge the battery regardless of its charge state.

HEINE DELTAone dermatoscope



[02]



DELTAone with contact plate with scale, USB cord with medical approved plug-in power supply, hard case.

	LED
DELTAone Standard Edition (black-silver) [01]	K-210.28.305
DELTAone White Edition (white-silver) [02]	K-211.28.305

∴ **Accessories can be found on page 042.**



Further articles / accessories

HEINE dermatoscopes

**DELTA 30**

Contact plate with scale [01]	K-000.34.220
Small contact plate [02] for the examination of difficult-to-access pigmented lesions	K-000.34.206
Charger 30 table charging station [03]	X-002.99.212

**DELTAone**

Contact plate with scale [04]	K-000.34.222
Small contact plate [05] for the examination of difficult-to-access pigmented lesions	K-000.24.207

**DELTA 30 and DELTAone**

The currently available iPhone* mounting cases for DELTA 30 and DELTAone can be found at www.heine.com/en/mounting-case-smartphone

Universal smartphone adapter to clamp-on [06]

Suitable for practically every smartphone with and without case for DELTA 30	K-000.34.272
for DELTAone	K-000.34.271

Universal smartphone connector adhesive [07]

Fits many common smartphone cases with smooth surface made of hard plastic, the camera must not protrude from the case	K-000.34.270
USB cord with E4-USB medical approved plug-in power supply	X-000.99.303

| Stethoscopes



HEINE GAMMA® STETHOSCOPES

- ∴ **Solid chest piece** and ideal weight avoid stray noise from manipulation and ensure excellent resonance. Hygienic matt chrome finish.
- ∴ **Chest piece with non-chill rims** for the comfort of the patients.
- ∴ Ergonomic, chrome-plated binaurals. Individually adjustable.
- ∴ **High-quality Y-piece tubing** for perfect acoustics and sound reproduction. Length 56 cm.
- ∴ **Latex-free** materials.

HEINE GAMMA® 3.1 Pulse Stethoscope

For fine acoustic performance.



- ∴ **Stethoscope with solid flat chest piece.** The chest piece can be easily inserted under the sphygmomanometer cuff.
- ∴ **High-quality membrane**, 44 mm diameter
- ∴ **Single-tube construction** with excellent sound transmission.
- ∴ **Includes ear olives** (large/soft) for sound insulation.
- ∴ **Optional available:** Ear olives, (small/hard) (M-000.09.946).

GAMMA 3.1

M-000.09.941

HEINE GAMMA® 3.2 Acoustic Stethoscope

For excellent acoustic performance.



Technical data as GAMMA 3.1, but with a double chest piece.

- ∴ **Combined double chest piece** with two different frequency ranges to choose from: A high-quality membrane on one side and a conical acoustic head on the other side.
- ∴ **High-quality membrane**, 44 mm diameter for excellent acoustic performance and sound transmission.
- ∴ **Cone diameter 30mm.**

GAMMA 3.2

M-000.09.942

HEINE GAMMA® 3.3 Acoustic Stethoscope

Technical data as GAMMA 3.2.

- ∴ **Reduced contact area** of 31 mm.



GAMMA 3.3

M-000.09.943

Loupes & headlights





HEINE HR 2.5x high resolution binocular loupes

With i-View loupe mount



HR 2.5x optics with i-View

- ∴ **Achromatic optics** for crisp, bright images with colour-correction.
- ∴ **Lightweight** (51 g).
- ∴ **Water-resistant.**
- ∴ **Independent adjustment** of left and right optics for perfect PD adjustment.
- ∴ **High magnification** with a large field of view and excellent depth of field.
- ∴ **i-View loupe mount** provides any angle of view and flips up the optics independently of the optional LoupeLight2.

HR 2.5x specifications

Working distance in mm	340	420	520
Field of view in mm	90	130	180
Depth of field in mm	110	180	260

HEINE HR 2.5x high resolution binocular loupes

With i-View loupe mount

HR 2.5x sets with i-View loupe mount



Set A



Set B
with S-GUARD



Set C
without
S-GUARD

Working distance in mm	340	420	520
Set A: HR 2.5x optics with i-View on S-FRAME protective lenses 2 sterilisable swivel levers retaining cord cleaning cloth carrying case	C-000.32.355	C-000.32.356	C-000.32.567
Set B: HR 2.5x optics with i-View on Professional L headband S-GUARD splash protection protective lenses 2 sterilisable swivel levers cleaning cloth	C-000.32.365	C-000.32.366	C-000.32.367
Set C (without S-GUARD): HR 2.5x optics with i-View on Professional L headband protective lenses 2 sterilisable swivel levers	C-000.32.865	C-000.32.866	C-000.32.867

HEINE HRP high resolution prismatic binocular loupes

With i-View loupe mount



HRP optics with i-View

- ∴ **Achromatic optics** for crisp, bright images from edge-to-edge.
- ∴ **Lightweight** (85 g).
- ∴ **Water-resistant**.
- ∴ **Independent adjustment** of left and right optics for perfect PD adjustment.
- ∴ **Highest magnification:** Choice of 3.5x, 4x and 6x.
- ∴ **i-View loupe mount** provides any angle of view and flips up the optics independently of the optional LoupeLight2.

HRP specifications

Working distance in mm	HRP 3.5 x/420	HRP 4 x/340	HRP 6 x/340
Field of view in mm	65	50	40
Depth of field in mm	60	40	30

HEINE HRP high resolution prismatic binocular loupes

With i-View loupe mount



Set A



Set B
with S-GUARD



Set C
without
S-GUARD

HRP sets with i-View loupe mount

Working distance in mm	HRP 3.5 x/420	HRP 4 x/340	HRP 6 x/340
Set A: HRP optics with i-View on S-FRAME Protective lenses 2 sterilisable swivel levers retaining cord cleaning cloth carrying case	C-000.32.430	C-000.32.431	C-000.32.432
Set B: HRP optics with i-View on Professional L headband S-GUARD splash protection protective lenses 2 sterilisable swivel levers cleaning cloth	C-000.32.440	C-000.32.441	C-000.32.442
Set C (without S-GUARD): HRP optics with i-View on Professional L headband protective lenses 2 sterilisable swivel levers	C-000.32.840	C-000.32.841	C-000.32.842

HEINE C2.3 binocular loupes

The cost-effective all-purpose loupe

Ideal for dental laboratories and general medical examination.



C2.3

- ∴ **Crisp, clear images.** Multi-coated, scratch-resistant silica glass lenses produce crisp, clear images.
- ∴ **Flexibility for precise adjustment.** Independently adjustable PD controls ensure precise alignment of the optics.
- ∴ **Super lightweight and comfortable – only 46g.** Flexible coil temples wrap-around to fit the user's anatomy securely and comfortably. Spring-loaded temples will adjust to the user's anatomy. Lightweight metal frame.
- ∴ **The ideal all-purpose loupe.** The feather-light weight, low-profile design and low cost of the C2.3 loupe make it the ideal all-purpose loupe.
- ∴ **Working distance.** 340mm or 450mm (13 or 18 inches).
- ∴ Also available as C2.3K on Lightweight headband.



C2.3K

Specifications	C2.3x/340 mm	C2.3x/450 mm
Magnification	2.3x	2.3x
Working distance	340 mm	450 mm
Field of view Ø	110 mm	130 mm
Weight	46 g	46 g
Depth of field	120 mm	190 mm

User's refractive error	Effective working distance C2.3x/340 mm	Effective working distance C2.3x/450 mm
+2	440 mm	670 mm
+1	390 mm	560 mm
0	340 mm	450 mm
-1	300 mm	420 mm
-2	270 mm	370 mm

Important information for those who wear glasses:

The C2.3K Series loupe can also be worn without the use of spectacles. Should you prefer to examine without glasses, the charts illustrate how your refractive error will affect the loupe working distance. If you are unsure of your prescription, please consult your eye care provider.

C2.3/C2.3K binocular loupes

C2.3/340 loupe in case	C-000.32.039
C2.3/450 loupe in case	C-000.32.202
C2.3K/340 headband loupe in case	C-000.32.230
C2.3K/450 headband loupe in case	C-000.32.231

HEINE LoupeLight2

Compact LED^{HQ} headlight – now even brighter

LED^{HQ}
LED IN HEINE QUALITY.



- ⌘ **There's LED. And there's LED^{HQ}.** HEINE has set a new standard which maintains that only the best is good enough, from the selection of materials to processing, from light intensity to dimmability, and from thermal management to a colour rendering index as high as possible. **That's what we call LED in HEINE Quality – or LED^{HQ}.**
- ⌘ **Compact, lightweight (50 g).** Ensures perfect comfort.
- ⌘ **Aluminium housing.** Exclusive aluminium housing protects the optics against dust and moisture to ensure an extraordinary long lifespan and optimal thermal management.
- ⌘ **Coaxial illumination:** Compact coaxial design ensures a completely shadow-free image and allows for excellent illumination of difficult to see areas.
- ⌘ **Optional filter.** Polarisation filter P2 improves contrast and yellow filter reduces blue light.
- ⌘ **Replaceable connecting cord** with high-quality splashproof threaded connector with a length of 1.5 m. Connects the LoupeLight2 with the mPack mini.
- ⌘ **Incl. coloured attachment clips for personalisation.** To fixate the cable and to identify your LoupeLight.

Technical specification

Illumination	Typ. 55 000 lux*
Colour temperature	Typ. 4 000 kelvin
LED operating life	Typ. 50 000 hours
Spot size	The illuminated field is designed to complement the HR/HRP loupes. 81 mm Ø at 420 mm, 95 mm Ø at 520 mm working distance
Angle of declination	Stepless and individually adjustable for every examination
Operating time	Typ. 9 h with mPack mini (in continuous operation at full power typ. 4 hours)

*Measured at a working distance of 180 mm from the light emission to the object.

- ⌘ **Precision multiple lens optical system** consisting of four high-quality lenses. Completely homogeneous illumination of the whole field of view and a clearly defined light spot.

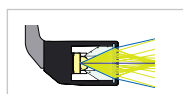

Conventional system [02]

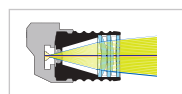

HEINE precision 4-lens system [03]



Comparison of homogeneity

HEINE mPack mini

Compact and lightweight power source for LoupeLight2



- ⌘ **Operating time typ. 9 hours.** In continuous operation at full power typ. 4 hours.
- ⌘ **Charging time typ. 4 hours.**
- ⌘ **Compact and lightweight.** With a weight of just 95 g and dimensions of 44 x 23 x 101 mm the power source can be easily stowed.
- ⌘ **For further information on the mPack mini, please see page 061.**



HEINE LoupeLight2 and accessories

Ordering information



LoupeLight2	
LoupeLight2 for HR/HRP loupes for i-View loupe mount [01]	C-008.32.226



LoupeLight2 with power source for i-View loupe mount (HR / HRP)	
LoupeLight2 with mPack mini and E4-USB plug-in transformer [02]	C-008.32.265
mPack mini belt clip [03]	X-000.99.006

* Not suitable for HR/HRP loupes with a rigid loupe mount.

For further information on the mPack mini, please see page 061. Power supplies may deviate in size and shape.

HEINE LoupeLight2 sets

With mPack mini and E4-USB plug-in transformer



LoupeLight2 sets with HR binocular loupes			
Magnification / working distance in mm	HR 2.5x/340	HR 2.5x/420	HR 2.5x/520
HR 2.5x optics with i-View on S-FRAME and LoupeLight2 detachable yellow filter mPack mini mPack mini belt clip E4-USB plug-in transformer connecting cord protective lenses 2 sterilisable levers retaining cord, cleaning cloth, case	C-008.32.450	C-008.32.451	C-008.32.452



LoupeLight2 sets with HRP binocular loupes			
Magnification / working distance in mm	HRP 3.5x/420	HRP 4x/340	HRP 6x/340
HRP optics with i-View on S-FRAME and LoupeLight2 detachable yellow filter mPack mini mPack mini belt clip E4-USB plug-in transformer connecting cord protective lenses 2 sterilisable levers retaining cord, cleaning cloth, case	C-008.32.453	C-008.32.454	C-008.32.455

HEINE ML4 LED HeadLight

Ultra bright coaxial LED^{HQ} illumination



Comparison of homogeneity
[01] Competitor product
[02] HEINE ML4 LED HeadLight



- ⌘ **There's LED. And there's LED^{HQ}.** HEINE has set a new standard which maintains that only the best is good enough, from the selection of materials to processing, from light intensity to dimmability, and from thermal management to a colour rendering index as high as possible. **That's what we call LED in HEINE Quality – or LED^{HQ}.**
- ⌘ **Adjustable illumination spot size:** 30 mm to 80 mm spot size range (at 420 mm working distance) to fit any examination situation.
- ⌘ **Bright and homogenous illumination.** Absolutely bright light spot that is uniform from edge-to-edge for the perfect illumination in all examination situations.
- ⌘ **Stepless light intensity control.** Optimal brightness setting prevents reflexes.
- ⌘ **Flexibility.** Flexible power source options: 100 % mobility with a choice of cable-free mPack UNPLUGGED head-worn battery or mPack belt-worn battery pack.
- ⌘ **Coaxial illumination.** Coaxial design ensures a completely shadow-free image and allows for excellent illumination of difficult to see areas.
- ⌘ **Comfortable and secure fit.** The Professional L headband has multiple adjustment points and soft padding for comfort and stability – even during long examinations.
- ⌘ **Optional filters.** Polarisation filter P2 improves contrast and yellow filter reduces blue light.

Technical Specification

Illumination	Typ. 90,000 lux*
Colour temperature	Typ. 5,500 kelvin
LED operating life	Typ. 50,000 hours
Spot adjustment	30 mm to 80 mm at 420 mm working distance
Angle of declination	Stepless and individually adjustable for every examination
Rheostat	Headband-mounted
Operating time	Typ. 8.5 hours with mPack and typ. 3.5 hours with mPack UNPLUGGED of continuous ON time at full power

*Measured at a working distance of 180mm from the light emission to the object.

HEINE ML4 LED HeadLight

Ordering Information



ML4 LED HeadLight with Professional L headband

ML4 LED HeadLight with mPack and plug-in transformer [01] + [03]	J-008.31.413
ML4 LED HeadLight with mPack UNPLUGGED and plug-in transformer UNPLUGGED [01] + [04]	J-008.31.415
ML4 LED HeadLight with wall mounted EN 50 UNPLUGGED charger and 2x mPack UNPLUGGED [01] + [05]	J-008.31.416

Power supplies may deviate in size and shape.





HEINE ML4 LED HeadLight with HR/HRP optics

The ML4 LED HeadLight is optionally supplied with HR/HRP binocular loupes incl. i-View loupe mount and with or without S-GUARD. The binocular loupe is fully adjustable for every examiner and for every examination axis.

- ∴ **HEINE S-GUARD:** Rapid and simple symmetric adjustment of binocular loupes with splash protection by protective lenses.
- ∴ **HEINE i-View for ML4 LED HeadLight:** Provides any angle of view and flips up the optics independently of the illumination beam.



ML4 LED HeadLight kits with S-GUARD and power source

The following kits contain: ML4 LED HeadLight on Professional L headband, HR/HRP optics with i-View and S-GUARD, mPack and plug-in transformer

Kit 1:	with HR binocular loupe	2.5x/340mm	J-008.31.440
Kit 2:	with HR binocular loupe	2.5x/420mm	J-008.31.441
Kit 11:	with HR binocular loupe	2.5x/520mm	J-008.31.450

ML4 LED HeadLight kits with power source without S-GUARD

The following kits contain: ML4 LED HeadLight on Professional L headband, HR/HRP optics with i-View, mPack and plug-in transformer

Kit 1c:	with HR binocular loupe	2.5x/340mm	J-008.31.452
Kit 2c:	with HR binocular loupe	2.5x/420mm	J-008.31.453
Kit 11c:	with HR binocular loupe	2.5x/520mm	J-008.31.463

For information on other configurations, please visit heine.com

HR/HRP binocular loupes – retrofitting sets

For HEINE ML4 LED HeadLight



Retrofitting set HR/HRP binocular loupes for ML4 LED HeadLight

The sets enable you to equip your existing ML4 LED HeadLight with a binocular loupe. The set contains HR/HRP optics with i-View and S-GUARD splash protection.

with HR binocular loupe	2.5x/340mm	J-000.31.370
with HR binocular loupe	2.5x/420mm	J-000.31.371
with HR binocular loupe	2.5x/520mm	J-000.31.365
with HRP binocular loupe	3.5x/420mm	J-000.31.372
with HRP binocular loupe	4x/340mm	J-000.31.373
with HRP binocular loupe	6x/340mm	J-000.31.374

5 sterilisable swivel levers for i-View loupe mount for ML4 LED HeadLight [01]

C-000.32.399

Power sources



mPack and plug-in transformer [01]

X-007.99.672

Plug-in transformer for ML4 LED HeadLight [02]

X-095.16.330

Power supplies may deviate in size and shape.

| Power sources





HEINE BETA® handle module



The handle module X-000.99.010, 145 mm x 30 mm Ø, is the basis of every BETA handle. By adding the appropriate bottom inserts it is possible to assemble any of the handles shown on this page. A BETA battery handle can also be converted to a rechargeable handle in this way. All BETA handles feature short-circuit protection and a continuous ceramic brightness control.

BETA handle module	X-000.99.010
--------------------	--------------

HEINE BETA® battery handle



BETA battery handle	2.5V
BETA battery handle (batteries not included; appropriate batteries: IEC LR14)	X-001.99.118
BETA bottom insert	X-000.99.119

HEINE mini 3000® battery handle



Innovative, compact battery handle in a high-quality, modern design. Suitable for all mini 3000 instruments.

- ∴ **Oval, compact, stylish shape.** Lies ergonomically in the hand.
- ∴ **High-quality handle: Chrome-finish upper section/refined plastic.** Shockproof, sturdy, non-slip.
- ∴ **Attachment clip with integrated on/off switch.** Secure. Switches off automatically when returned to the pocket. 20.000 switch cycles guaranteed.
- ∴ **Screw-on end cap.** For easy battery change.
- ∴ **Threaded connector made of metal.** Prevents wear.
- ∴ **Replaceable batteries.** Size AA, or optional rechargeable battery with mini NT table charger.
- ∴ **Complete range of mini 3000 instruments.** Versatile range.
- ∴ **Registered design.**
- ∴ **Rechargeable mini 3000 handle.** The mini 3000 battery handle can be retro-fitted with the mini rechargeable battery 2.5V NiMH and the bottom insert to update to the mini 3000 rechargeable handle. Fully-automatic charging with the mini NT table charger.

mini 3000 battery handle	2.5V
with two dry batteries IEC LR6 (AA size)	D-001.79.021

To upgrade to a rechargeable instrument with mini NT table charger, please see www.heine.com

HEINE BETA® 4 rechargeable handles

Next-generation energy management



- ⌘ **High-quality metal construction** for strength and durability.
- ⌘ **Exclusive automatic connector with locking design.** No metal on metal friction which can wear out over time, for a secure fit for the lifetime of your instruments.
- ⌘ **Deep battery discharge protection:** Integrated safety system protects your investment by preventing batteries from completely draining; thus ensuring maximum battery life.
- ⌘ **Familiar brightness control:** Rheostat for continuous brightness control with power level indicator.
- ⌘ **Li-ion technology:** no “memory effect”. Charge your handle how you like without worrying about charge level or battery condition.
- ⌘ **Extended ON time:** work typ. 6 weeks between recharging with LED instruments.
- ⌘ **Quick charge.**
- ⌘ Slightly knurled finish of the handle provides a **non-slip grip but is easy to clean and disinfect.**
- ⌘ **Charge status indicator** in the bottom insert: the indicator shines orange if the battery needs to be recharged. In the BETA4 USB Handle the indicator blinks green during the charging process and shines permanently green as soon as it is fully charged.

BETA4 NT rechargeable handle for NT4 table charger



- ⌘ **Ready-to-use function.** Handles switch ON & OFF automatically when placed into charger. Set your desired brightness level once and it stays there every time you use your instrument. Also prevents battery damage and premature bulb burn outs if the instruments are accidentally left on.

Not compatible with the NT 300 table charger and the previous generations.

	3.5V Li-ion
Rechargeable handle complete with Li-ion rechargeable battery and BETA4 NT bottom insert	X-007.99.396
BETA4 NT bottom insert	X-002.99.394
Li-ion rechargeable battery for BETA4 rechargeable handle	X-007.99.383

BETA4 USB Li-ion rechargeable handle



- ⌘ **Maximum safety.** You can charge your HEINE BETA4 USB handle with any USB plug or other USB power source, with absolute peace of mind. The BETA4 USB handle has an integrated, exclusive galvanic separation module that protects the handle, and the user, even if a faulty or inferior plug is used; thus preventing the possibility of the full mains voltage flowing directly to the handle. We do however recommend the use of a medical approved plug-in power supply.

	3.5V Li-ion
Rechargeable handle complete with Li-ion rechargeable battery, BETA4 USB bottom insert, USB cord with medical approved plug-in power supply and handle rest	X-007.99.388
Li-ion rechargeable battery for BETA4 rechargeable handle	X-007.99.383
BETA4 USB bottom insert	X-002.99.395



HEINE NT4 table charger



Dimensions: Width 142 mm, height 61 mm, depth 66 mm.
 With the appropriate adaptor set all BETA4 NT and BETA4 SLIM NT rechargeable handles can be charged in the NT4 table charger. The same applies to all Standard F.O.4 NT, F.O.4 SLIM NT and F.O.4 SHORT NT laryngoscope rechargeable handles.

- ∴ **Innovative, compact design.** Practical and space-saving.
- ∴ **Two independent charging wells.** Complete functionality for one or two handles at a time.
- ∴ **Automatic charging.** Independent of the state of charge of the rechargeable battery. Guarantees extended battery life.
- ∴ **Cannot be overcharged.** Charger switches off automatically when the battery is fully charged.
- ∴ **Charge status indicator.** Light pulses from the charging well to confirm the charging mode. Continuous light indicates that the charging process has been completed.

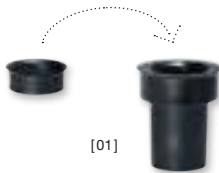

NT4 table charger	
without handle, with adaptor. For BETA4 NT rechargeable handles, Standard F.O.4 NT and F.O.4 SHORT NT laryngoscope rechargeable handles. BETA4 SLIM NT rechargeable handles and F.O.4 SLIM NT laryngoscope rechargeable handles (adaptor set required X-000.99.086).	X-002.99.494
Adaptor set (two pieces) for BETA4 SLIM NT rechargeable handles and F.O.4 SLIM NT laryngoscope rechargeable handles [01]	X-000.99.086

∴ **Not suitable for rechargeable handles of the previous generations such as BETA L, BETA NT, BETA SLIM and Standard/Small/Short F.O. laryngoscope handle.**

HEINE BETA®4 upgrade kits

For converting to HEINE BETA4 charging technology

For simple conversion of an older HEINE BETA R rechargeable handle or a BETA TR rechargeable handle (both discontinued) to the current generation of BETA4 USB rechargeable handles featuring modern Li-ion technology.



Upgrade kit BETA4 USB	3.5V Li-ion
BETA4 USB bottom insert, Li-ion L rechargeable battery, E4-USB plug-in power supply and USB cord, handle rest	X-010.99.388



For simple conversion of a BETA L rechargeable handle to the current BETA4 NT generation of handles.

Upgrade kit BETA4 NT	3.5V Li-ion
BETA4 NT bottom insert, NT4 table charger	X-010.99.420



For simple conversion of a BETA NT rechargeable handle (with Ni-MH rechargeable battery) to a BETA4 NT rechargeable handle with modern Li-ion technology.

Upgrade kit BETA4 NT	3.5V Li-ion
BETA4 NT bottom insert, Li-ion L rechargeable battery, NT4 table charger	X-011.99.420

HEINE EN 200 diagnostic centre – individual

Put together your individual diagnostic centre: The EN 200 wall transformer and additional components such as the AllSpec tip dispenser can be combined in a modular system. You can also select the instruments you need (3.5 V XHL or LED version) individually from the HEINE range and customise your diagnostic centre to meet your individual requirements.

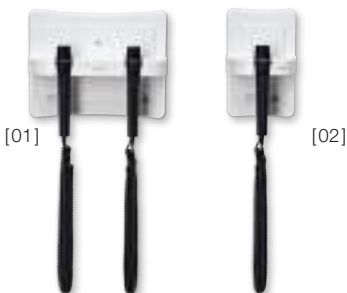

EN 200 wall transformer* [01]	X-095.12.250
EN 200-1 wall transformer* (extension unit with one handle) for use with the EN 200 wall transformer (with short USB cord) [02]	X-095.12.251
EN 200-1 wall transformer* (single unit with one handle) as single module with long USB cord and E 4-USB plug-in power supply [02]	X-095.12.252
AllSpec tip dispenser, for EN 200 [03]	B-000.11.149

* without instruments

HEINE CC1 charging case for OMEGA 600



The CC1 charging case allows you to charge a second battery while you continue working with your instrument. Charging time typ. 1.5 hours.

CC1 charging case

X-000.99.091

HEINE CB1 charging battery for OMEGA 600



The CB1 charging battery for OMEGA 600 is a compact, lightweight lithium polymer battery. It has an operating time of up to 8 hours depending on illumination intensity. An extra battery offers you even more flexibility as you can charge one battery while you continue working with your instrument. Can be charged separately from the OMEGA 600 in the CC1 charging case.

CB1 charging battery

X-007.99.687

HEINE OMEGA 600 charging set



The OMEGA 600 charging set **includes a CC1 charging case and CB1 charging battery**. This set offers you even more flexibility as you can charge the second battery while you continue working with your instrument.

OMEGA 600 charging set: CC1 charging case and
CB1 charging battery

X-000.99.090

HEINE E4-USBC power supply for OMEGA 600



Easy plug-in power supply with USB-C cable for charging the OMEGA 600. Approved for medical use.

E4-USBC power supply with cable

X-000.99.300

HEINE CW1 wall charger for OMEGA 600



The CW1 wall charger offers a convenient charging possibility between examinations to make sure your OMEGA 600 is always charged and ready to use when you need it. The design of the charger protects the OMEGA 600 from accidental fall.

- ∴ The OMEGA 600 can be charged directly at the CW1 wall charger.
- ∴ Automatic switch-off of the OMEGA 600 in the wall charger.
- ∴ Charging time typ. 1.5 hours.

CW1 wallcharger (without OMEGA 600)

X-095.17.320

Wall transformer HEINE EN 50 UNPLUGGED

Intelligent charger for mPack UNPLUGGED



- ⌘ **Charger and wall-mount in one.** The wall transformer serves as an instrument holder and a charger at the same time.
- ⌘ **Intelligent charging system.** The instrument automatically switches off and goes into charging mode when placed in wall transformer. It is impossible to overcharge the mPack UNPLUGGED; the process ends automatically when charging is completed.
- ⌘ **Simultaneous charging.** The charging system charges the battery on the headband as well as an additional single spare battery.
- ⌘ **Compatible transformer (100 – 240V).** Multi-voltage power supply unit incl. 4 different mains adaptors.
- ⌘ **Registered design.**

Wall transformer EN 50 UNPLUGGED
(without mPack UNPLUGGED) 6V

X-095.17.310

HEINE mPack UNPLUGGED

Headband-mounted rechargeable battery



[01]



- Rechargeable battery for ML4 LED HeadLight UNPLUGGED (system voltage 6V).
- ⌘ **Lightweight with balanced weight distribution.** High level of comfort.
 - ⌘ **Charge status indicator.** Display of remaining operating time.
 - ⌘ Can be recharged by **wall- or plug-in transformer.**
 - ⌘ **Direct operation possible while charging** through the use of the mobile plug-in transformer.
 - ⌘ **Charging time:** typ. 2 hours.
 - ⌘ **Operating time:** typ. 3.5 hours for ML4 LED HeadLight.
 - ⌘ **Intelligent charging system.** Automatic changeover from operating to charging mode (in the wall unit).
 - ⌘ **Top safety standards.** Integrated charge and performance checks during operation. Lithium polymer technology. UL-compliant.
 - ⌘ **Registered design.**

mPack UNPLUGGED

mPack UNPLUGGED

X-007.99.665

Transformer UNPLUGGED for mPack UNPLUGGED [01]

X-095.16.316

Lithium polymer rechargeable battery for mPack UNPLUGGED

X-007.99.680

Extension cord from plug-in transformer UNPLUGGED to mPack UNPLUGGED, 2 m [02]

X-000.99.668



[02]



HEINE mPack

Portable power pack for ML4 HeadLight



[01]



[02]



[03]

- ∴ **Freedom from cables** that tie the user to desk, wall or static power supplies.
- ∴ **Triple the capacity with Li-ion technology.** Compared with current NiCd systems. When fully charged at least 3x the capacity of conventional NiCd systems. More than double of other Li-ion systems. No memory effect.
- ∴ **Fast charge.** Charges to full capacity in typ. 2 hours.
- ∴ **Charge status indicator.** Always lets you know how much operating charge you have left.
- ∴ **Operating time:** typ. 8.5 hours for ML4 LED HeadLight.
- ∴ **Flexible charging options.** Charge in the EN 50 charger base station, or with mobile plug-in transformer.
- ∴ **Intelligent.** Automatically switches to “charge” mode when inserted in EN 50. Can also be used as mains power supply even while in “charge” mode.
- ∴ **Automatic remote power adjustment** for compatibility with all HEINE 6V and selected LED instruments.
- ∴ **Stepless light intensity control 0.5 – 100 %.** Optimum brightness setting prevents reflexes.
- ∴ **100 – 240V compatible transformer** incl. 4 plugs for world wide compatibility.

mPack	6V
EN 50-m charger wall/ table unit with mPack , (incl. 90° angled adaptor, Instrument support for Professional L headband [01])	X-095.17.302
mPack with Li-ion rechargeable battery and plug-in transformer	X-007.99.672
mPack with Li-ion rechargeable battery, without transformer	X-007.99.671
Li-ion rechargeable battery for mPack	X-007.99.686
Plug-in transformer for mPack [02]	X-095.16.315
Plug-in 90° angled adaptor (for EN 50 charger/mPack) [03]	C-000.33.509

HEINE mPack mini

Power source for LoupeLight2



[01]

- ∴ **Freedom from cables** that tie the user to desk, wall or static power supplies.
- ∴ **Operating time LoupeLight2:** Typ. 9 hours in everyday practical use. In continuous operation at full power typ. 4 hours.
- ∴ **Charging time typ. 4 hours.**
- ∴ **Charge status indicator.** Display of remaining battery power with three LEDs. The flashing of the last LED indicates that immediate charging is required. During charging the LEDs light up one after the other.
- ∴ **Stepless light intensity control.** Optimum brightness setting between 100% and 3% reduces reflexes.
- ∴ **USB cord** with E4-USB medical approved plug-in power supply.
- ∴ **The integrated galvanic separation module** protects the battery and the user against the consequences of defective power supplies, thus preventing the possibility of the full mains voltage flowing directly to the housing. We recommend the use of a medical approved plug-in power supply.
- ∴ **Simple cleaning.** Closed housing, no seams at the sides, few edges.
- ∴ **Compact and lightweight.** With a weight of just 95g and dimensions of 44 x 23 x 101mm the power source can be easily stowed.
- ∴ **Optimised mPack mini belt clip** for simple attachment of the power source to the belt or waistband. The mPack mini can also be charged in the belt clip [01].
- ∴ **Li-ion technology.** No „memory effect“, without worrying about charge level or battery condition.
- ∴ **Integrated rechargeable battery.** Can be exchanged at authorised specialist dealers.

mPack mini	6V
mPack mini with Li-ion rechargeable battery and E4-USB plug-in transformer	X-007.99.650
mPack mini with Li-ion rechargeable battery, without E4-USB plug-in transformer	X-007.99.649
mPack mini belt clip [02]	X-000.99.006
USB cord [03] with E4-USB plug-in transformer [04]	X-000.99.303
E4-USB medical approved plug-in power supply for USB cord [04]	X-000.99.305



[02]



[03]



[04]

The first part of the document discusses the importance of maintaining accurate records of all transactions. This includes not only sales and purchases but also any other financial activities that may occur. It is essential to ensure that all entries are properly documented and supported by appropriate evidence.

In addition, the document emphasizes the need for regular reconciliation of accounts. This process involves comparing the company's internal records with the bank statements to identify any discrepancies. By doing so, the company can ensure that its financial statements are accurate and reliable.

Furthermore, the document highlights the significance of maintaining up-to-date financial statements. These statements provide a clear and concise overview of the company's financial performance over a specific period. They are essential for making informed decisions and for communicating the company's financial health to stakeholders.

Finally, the document stresses the importance of seeking professional advice when needed. Accountants and financial advisors can provide valuable insights and guidance, helping the company to optimize its financial operations and ensure compliance with relevant regulations.

HEINE QUALITY
MADE IN GERMANY

Standard 5 year parts and labor guarantee

All HEINE products carry a 5 year parts and labor guarantee against defects in design, materials and workmanship. Excluded from this are wear and tear, single-use items and consumables as well as rechargeable batteries and exposed and accessible control and supply cables with corresponding plug connection.

For details please visit www.heine.com.



Product-related guarantee conditions

for the HEINE visionPRO video laryngoscope and HEINE fiber optic laryngoscope blades are available at: www.heine.com/en/service-support/guarantee

© HEINE Optotechnik GmbH & Co. KG. Printed in Germany, 12.2022

All information, specifications and illustrations contained in this catalogue are based on the latest product information available at the time of publication.

Errors and omissions excepted. HEINE Optotechnik GmbH & Co. KG reserves the right to change specifications and design at any time without prior notice. This document must not be copied, reprinted or reproduced in any form, either wholly or in part without the written consent of HEINE Optotechnik GmbH & Co. KG.

Please observe the General Terms and Conditions of HEINE Optotechnik GmbH & Co. KG.
For our General Terms and Conditions, please refer to: www.heine.com

Due to local regulations, some products may not be available in your country.



QUALITY made in GERMANY.

As a global leader in the manufacture of primary diagnostic instruments with over 500 employees, HEINE Optotechnik has been a 100% family owned and managed company for more than 75 years. We continue to develop and manufacture HEINE instruments at our facilities in Germany, where we combine decades-long experience and craftsmanship with the most modern manufacturing technologies.

We are represented in over 120 countries around the world, with subsidiaries in the US, Canada, Australia and Switzerland as well as 3,000 representatives, importers and specialist dealers.

We look forward to hearing from you – and would like to know more about your opinions, desires and suggestions regarding our products.

Your distributor

