



Professional Breath Alcohol Analyzer

With Fuel Cell Sensor



Model: AP-338

Version: 1.0

IMPORTANT: Many factors (e.g. environment gas residue, smoke & various smell in human mouth, etc...) may affect the Blood Alcohol Concentration (BAC) level, so the Readings are For Reference Only.

Neither the reseller nor manufacturer accept any liability arising from the use of this unit.

DO NOT drink before you drive!

www.aap.com.hk

Contents

	Page
Measuring instrument.....	2
Packing List	3
Basic Scientific Principles.....	4
Maintenance.....	4
Intended Use.....	4
General Conditions.....	5
Power & Charging.....	5
Operation instructions.....	5
Active Test.....	5-7
Quick Test.....	7
Test record.....	8
Sensor Test.....	8
System Setting.....	9
GPS.....	10
Clock and Torch.....	10
Specification.....	11
Calibration and Service.....	11

Measuring instrument

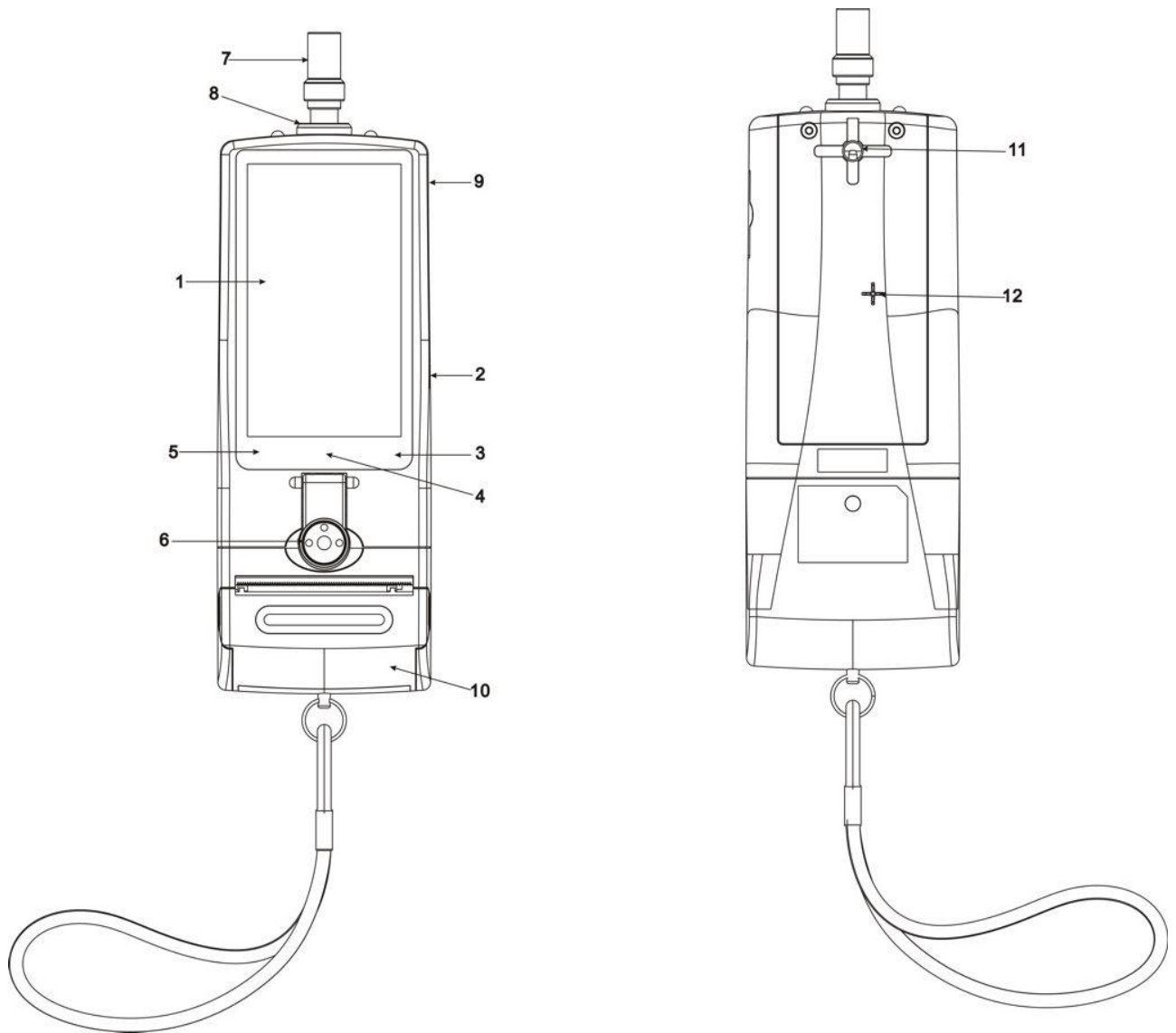

- 1. LCD display with touch panel
- 2. Power Key
- 3. Back Key
- 4. Home Key
- 5. Function Key
- 6. Camera
- 7. Mouth piece
- 8. Inner tube
- 9. USB Jack(Connect computer/Charging)
- 10. Printer
- 11. Gas Outlet 1
- 12. Gas Outlet 2

Packing list

1. Measuring instrument
2. Mouthpiece, 25pcs
3. Big mouthpiece (connect the mouthpiece to blowing), 1pc
4. Leather sheath, 1pc
5. Printer paper, 4pcs
6. USB cable , 1pc
7. Car adaptor (connect the unit machine directly charging in the car), 1pc
8. USB Charger,1pc
10. CD for Download software,1pc
- 11.User manual 1pc

Thanks for purchasing our AP-338 Professional Fuel Cell Digital Alcohol Analyzer. AP-338 gives you a precision digital indication of your breath alcohol content and thus your possible concentration of intoxication. To achieve the high accuracy, user should study this manual carefully. And any use of the AP338 requires full understanding and strict observation of these instructions.

Basic Scientific Principles

Fuel Cell sensor is using the electrochemical reaction for platinum against ethanol molecules, gives the most stable and reliable measuring technology.

Declaration: This manual should be read before use.

Liability for proper function or damage

Never unscrew the AP-338. **Warranty not valid** if any screws had being loosened or warranty label had being broken. Serviced or repaired by personnel not employed by Service center or authorized or if the instrument is used in a manner not conforming to its intended use.

Maintenance

Repair/maintenance of the AP-338 should only be carried out by trained technician from authorized professional breath alcohol tester Service Center.

Only authentic spare parts can be used for maintenance.

Intended Use

- * Don't put this product in high temperature, high humidity or high dust environment.
- * Don't knock this product, especially do not press the TFT-LCD by force.
- * Don't dismantle the machine and use the alcohol, thinner or benzene to clean the surface of the product and its components.
- * Don't use in the area prohibiting using of wireless devices.
- * Don't use in the flammable and explosive environment.
- * Please use the touch pen when doing the touch screen calibration
- * Before use, please fully charge up the Handset using the provided accessory charger.

General Conditions

- Use a new mouthpiece for each test or each person being tested.
- Make sure no alcohol and solvent vapors (disinfectants) in the ambient air.
- Do not allow a high alcohol concentration to reach the sensor. For instance, from drinking alcohol, eating alcohol containing foods or rinsing the mouth with alcohol mouth washer just before measurement.
- Keep away from the antenna of mobile phones or transmitters.

Conditions for Tested Person

To begin, rinse out your mouth with water or non-alcoholic drinks before using the unit. Abstain from smoking (for 15 minutes) or drinking (for at least 15 minutes.) Actual residues of alcohol in the mouth may enhance the measured values. This may also occur by aromatic drinks (e.g. fruit juices), alcoholic mouthwashes or mouth sprays, medicines and drops, as well as by burping and vomiting.

Breathe evenly and normally before the test.

Important:

DO NOT EAT, DRINK, OR SMOKE FOR 15 MINUTES PRIOR TO UNDERTAKING A TEST. FAILURE TO DO SO MAY IMPAIR RESULTS AND DAMAGE THE UNIT.

REMEMBER: NEVER DRINK & DRIVE – THE ONLY SAFE LEVEL IS ZERO

Power & Charging

- If the battery symbol on the display indicates “empty”, please charge it as soon as possible.

Put in the provided power adaptor to charge. Or connect with provided car charger in car to charge the battery.

Unit battery symbol display charging 

Power ON/OFF

1. Press the “Power Key” for 2 seconds to turn ON the machine then enter into the main interface.
2. Press and hold the “Power Key” for about 2 seconds to turn OFF the machine.
3. If no key input for 10 minutes, the machine will auto power off.
3 minutes for enter screen saver. (it can set in Advanced setting)

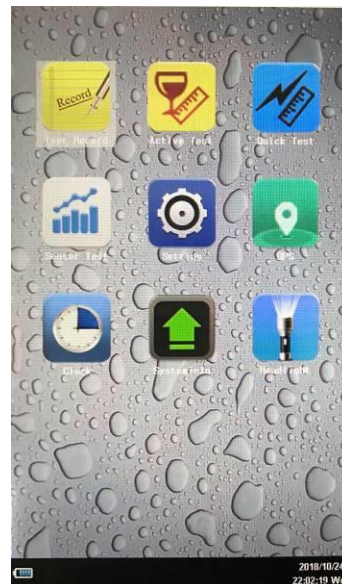

Operation instructions



1. **Active Test:** Under this test mode, the device will initialize the sensor condition. In some case, it need take few seconds to 2 minutes.

1.1 Insert a new mouthpiece in **CORRECT** orientation into the inner tube chamber inlet..

- 1.2 Press the “” icon on the main menu, The LCD will shows “**Tester Ready, Please Blow Continuously**”, user can start the alcohol test.

Evenly blow into the mouth piece for about 3-6 seconds with a continuous “Beep” sound announcement. (**Active test**)
The blowing time is related to the blowing pressure.

- 1.3 If the breath sample flow rate is too soft or blowing duration is too short, “Blow Abort or too Short” will be shown on the display. The machine will return to the main menu automatically. Repeat 1.1 & 1.2 to test again.

Active test:

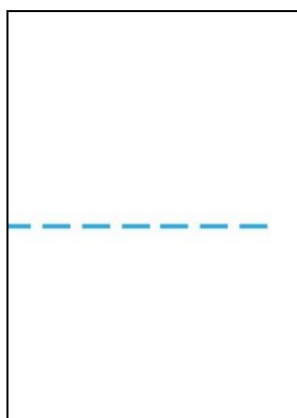

Ready-blow

blowing

sampling

test result

1.4 If the breath sample is taken successfully, the display will show “**Sampling...Please wait**”
The machine will analyze the breath sample and the test result will then be shown on the display after analyzing.

1.5 Press “Retest” icon to start another test or press “**Save**” to input the relevant information.
Press “**Return**” to return back into the main menu;



1.6 If the breath sample is taken not successfully. Then “**blow time-out**” or “**blow abort**” will show as following.
User need to re-test again.

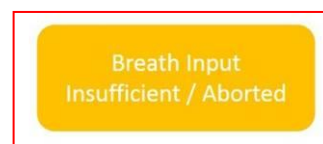

1.7 Press “**Save**” to input the relevant pictures below:

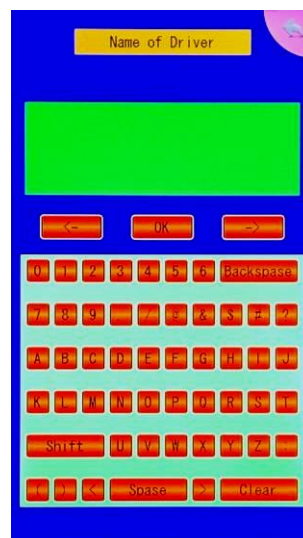
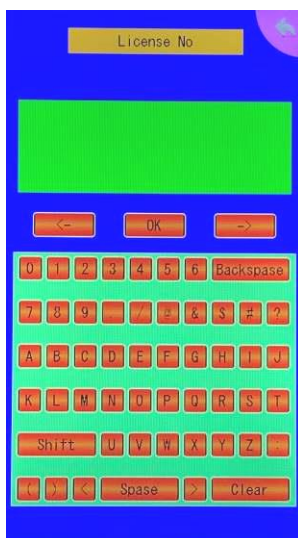

After inputted the relevant information, the Print or Retest interface will display on the LCD.

Press “**Print**” key to print out the test result or Press “**Retest**” to start another test or Press “**Return**” key to return back.

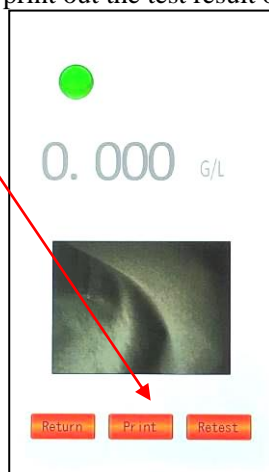

The Printout contains: instrument name & number, Police information, Driver information, Test Date & Time, Vehicle Number & Test result.

To ensure the accuracy and no environment residue, the machine should rest for 3 minutes for each test to avoid residue alcohol. Also, need to change the mouthpiece for each test.

To ensure the accuracy

1. Wait for 2 minutes to perform the 2nd test
2. Blow fresh air to clear the residue
3. Change a new mouth piece for each test

If continually use the machine for more than 15 minutes or water vapor condenses inside the inner tube, please blow fresh air to clean the inner tube (or allow the device to rest for 15 minutes.)



2. Quick Start; - Under this mode, the device allow to test without initialize sensor condition. Eg: temperature & residual alcohol.

It can ready to test within 1 second.

Repeat the 1.1 – 1.8 to do the quick breath alcohol test.

Passive test: Press “Power” key for taking breath sample.



Ready-blow

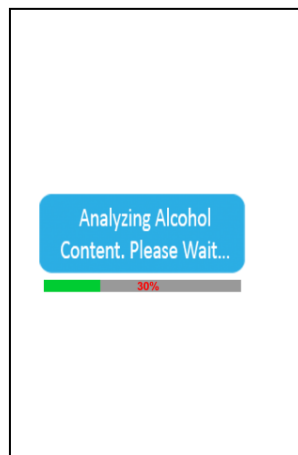

sampling

Or blow in for 1-2 seconds to take breath sample



3. Test Record: this menu to review the records, user can print the record, delete record, and clear all record.

- 4.1. Review all records by pressing “←” or “→” icon.
- 4.2. Print: print out the test record, also can print out the photo after show the photo.

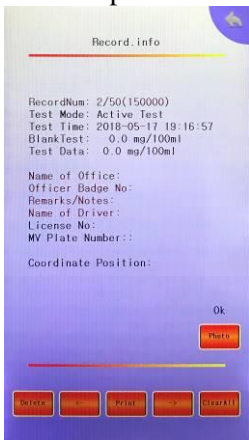

- 4.3. Delete: to delete the test record, need input user password
- 4.4. Exit: return to previous menu.
- 4.5 Delete all record: need input user password.

4. Sensor Test:



Press “Sensor Test” icon and enter the sensor test screen. Press “Auto” icon, then blow **alcohol breath** (about 0.05%BAC) into chamber through the blow tube for about six seconds and observe the sensor sensitivity & waveform as attached. If the curve is a straight line, it means the sensor already lost the sensitivity and need to change a new sensor.

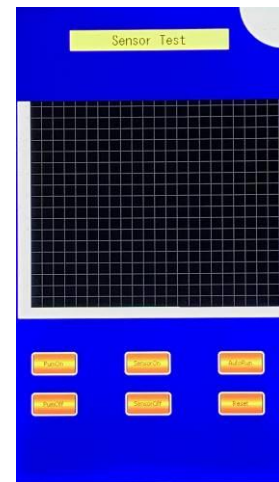

5. System Setting (Available for Service Center only):

Select the “” menu, and input the password (The default password is nothing, only press the OK key to enter into the system setting). Then, shows the sub-menu as following: “CAL TEST”, “CAL Flow”, “SET LANGUAGE”, “SET PASSWORD”, “SET UNIT”, “USB CONNECT PC”, “Advanced Setting”.

Caution: The calibration is already been done before shipping, user alters the setting parameters will override all calibration data. Only FiT authorized technician is allowed to modify the calibration data.

① “CAL TEST”: This is the test for verification the accuracy for Lab Certification / Verification only.

② “CAL Flow”: calibration breath blowing flow/ pressure.

Please blow to the device use 15 Liter/minute flow for 6 seconds, with device has Long “beep...!” Sound. A “beep beep” sound when finish. Screen shows flow data, press “Save” to save the date. Or press “Restart” to try again.

Or press “return” icon to exit the flow calibration menu.

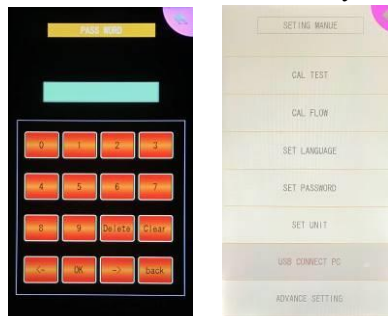

③ “SET LANGUAGE”: user may have different language

④ “SET PASSWORD”: default user password is empty. User can set user own password
If forget password, you make need to send back to service center to re-set it.

⑤ “Set Unit”

Set the unit to Permillage (%oBAC), Percentage (%BAC) and mg/L, mg/ml, mg/100ml and g/l. as picture.

For advanced user, it may set the BrAC ratio: 2100, 2000, 2200, 2300.

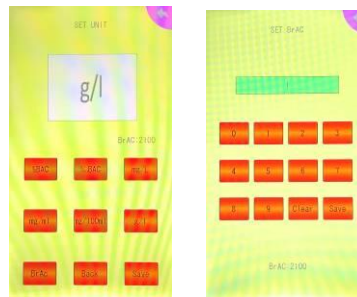

⑥ “USB CONNECT PC” : user can download the records and photos to the PC computer with a PC software and USB cable. Read the PC download manual for more details.

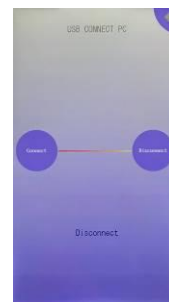

⑦ “Advanced Setting”

Advanced Setting: For Authorized service center only
(Super-user password is required)

Only allowed to perform this function by authorized service center

6. GPS



If user want the test result record with GPS coordinate position, please enter into the  menu, to start the GPS position detection.

After successful locating, then make the alcohol test with GPS record. See picture below for your reference.



Remark:

1. The GPS Module will take about 5~20 minutes while the first time to use this function.
2. In the spacious places GPS position will take less time than in the places with dense buildings.

7. Clock:



User can set the device data and time under this manual.

1. click the upper left corner setting icon to enter date and time setting interface. After change, press “OK” to save the setting. Press “back” to exit without save.
2. Return to main menu by click the return icon at the upper right corner

8. System information



9. Torch:



ON/OFF the build in LED in front of the device. Check the driver at the roadside, it is helpful.

10. Specification

1. product description:	Law Enforcement Alcohol Tester with Electrochemical / Fuel Cell Sensor
2. Built in thermal printer:	Heat transfer printer
3. Display:	4.5 Inch iPS LCD display
4. Input:	Touch Panel
5. Quick and precise analysis:	Ensure a high sensitivity to alcohol and stable & reliable working life.
6. Data download:	PC down via USB port.
7. Mouthpiece:	Easy to replace a new mouthpiece by pressing a key, very convenient and hygiene.
8. Power Supply:	Rechargeable 3.7 V Li-ion battery
9. Heat warm up:	Chamber & Sensor warm up automatically
10. Auto flow monitoring:	Flow detect automatically
11. Unit setting:	mg/L, mg/100mL, %BAC, ‰BAC, mg/ml, g/l
12. Display range:	0~0.9% BAC or 0~9.0‰ BAC or 0~4.5mg/l or higher
13. Long Term Storage condition:	Temperature: -20 Degree C to +55 Degree C.. Humidity: 30 to 90% RH
14. Operating Temperature:	From -20°C to +45 °C, (5°C to +40 °C for optimum operation)
15. Memories:	Min. 150,000 memories with full information:- Drive name, vehicle no., inspector name, test result with time stamp, date and time, location, instrument no., Calibration date, test no. etc...
16. Measurement precision:	Standard deviation +/-0.025 mg/L or +/-5 % of the measurement at calibration point Drift: typically < 0.8 % of the measurement value/month
17. Alert level setting:	Set “drunk driving” and “driving while intoxicated” by a supervisor password.
18. Size and weigh:	Approx. 208*78*37mm/360g
19. Calibration:	12 months by exchange the pre-calibrated sensor module.

11. Calibration and Service:

Does the tester require calibration? Yes. While some 'novelty' breathalyzers cannot be recalibrated, serious devices such as the tester must and can be recalibrated to ensure consistent accuracy. Consumers should be wary of units that cannot be calibrated as their accuracy will eventually waver. We provides a calibration service which can be organized by e-mailing sales@aap.com.hk

12. How often should I re-calibrate the tester or change a new sensor module?

The tester can remain accurate for 1 year of use. The more frequent the use, the more the unit will need to be calibrated. According to DIN31051, we recommend recalibration every 12 months (or earlier) basis to ensure maximum accuracy.

Please contact the Authorized service center or reseller to Purchase a Factory Pre-Calibrated Sensor module or Calibrate your device.

NB* It is important to observe the recommended 15 minute pause without consuming any alcohol, cigarettes or anything else before testing. Failure to do this can shorten the life of the sensor. In such cases, the sensor can be permanently damaged or may need more frequent calibration. This user manual should be read carefully for information on caring for the unit sensor.

Each test change new mouth piece, for best performance, wait for 3 minutes between each test.

Many factors (e.g. environment gas residue, smoke & various smell in human mouth, etc...) may affect the BAC level, so the readings are For Reference Only. Neither the reseller nor manufacturer accepts any liability arising from the use of the unit. Don't drink before you drive!

Made in China.